

TAPS &  
SHOWERS

[mayfairtapsandshowers.com](http://mayfairtapsandshowers.com)

PRODUCT &  
PRICE GUIDE  
03

mayfair



design,  
cost,  
service  
& quality

are the  
foundations  
of our  
business

mayfair

# FEATURES MADE EASY

This collection of simple icons will help you to understand the features of each product more clearly.

## CD CERAMIC DISC CARTRIDGE

A simple device that improves the performance of your tap and gives it a longer life.

## QT QUARTER TURN

This range of taps can turn on and off with a quarter turn mechanism for ease of action and on/off flow.

## HP HIGH PRESSURE

Works on a minimum pressure of 0.5 or above.

## TC THERMOSTATIC CONTROL

A temperature controlling system which prevents sudden changes in water temperature therefore reducing the chance of scalding.

## WS WATER SAVING

Compatible with Neoperl® water flow regulators, which limits the flow of water at a pressure above 1 bar. A perfect solution for water saving requirements.

## LP LOW PRESSURE

Works on a minimum pressure 0.2 bar or above.

## CT CARTRIDGE TECHNOLOGY

Single lever cartridge allows easy adjustment of water flow. Moving the lever back controls the flow whilst moving the lever left and right controls the temperature.

## CV COMPRESSION VALVE

Compression valves require several full turns to open the valves fully. Traditionally found on kitchen taps or classic style taps.



Design, cost, service and quality are the foundations of our business. Always at the cutting edge, we are constantly creating and manufacturing products we know the customer will want at a price that's affordable.

Our closely controlled supply chain from conception right through to manufacture is streamlined and flexible. Mayfair's overseas manufacturing and offices in China, allow us to offer customers a competitive and flexible package to suit specific time frames and budgets. Our presence overseas also means we can maintain a tight control on cost and quality targets.

With 20 years of business experience behind us, we value the importance of developing and maintaining strong relationships with clients. Care is always taken to develop a culture of high quality customer service so you can be assured of a friendly and honest approach from our staff.

We supply a full range of products from high-end contemporary looks through to more classic options. Whether it be a premium or budget option, our attention to detail and stringent sample approval processes mean that all Mayfair taps, mixers and showers are carefully designed and manufactured with clear emphasis on quality.

mayfair

NEW  
PRODUCT



# TAPS & SHOWERS

## CONTENTS

<b>NEW TRENDS</b> The very latest trends in the marketplace.	01_34
<b>CONTEMPORARY</b> Fresh, modern designs with sleek, cool lines.	35_86
<b>CLASSIC</b> Traditionally styled taps, beautifully updated and crafted in modern materials for a reassuring durability.	87_96
<b>FREESTANDING MONOS</b> For maximum impact alongside freestanding basins and sinks.	97_104
<b>BASICS</b> A full range of basic taps to suit any style of bathroom.	105_112
<b>KITCHEN</b> Reassuringly robust kitchen taps, with design influences ranging from traditional, modern, industrial, minimalist and classic styles.	113_122
<b>THERMOSTATIC SHOWERS</b> A full range of contemporary and traditional thermostatic showers to suit any bathroom.	123_138
<b>ACCESSORIES</b> The perfect finishing touch - bottle traps and wastes to complement your new taps and showers.	139_143
<b>TECHNICAL INFORMATION</b> More detailed information on each and every Mayfair product.	144_167



PRODUCT GUIDE

# NEW TRENDS





FLOW RANGE















		
<p>FLW005 £291 BATH FILLER</p>	<p>FLW007 £319 BATH SHOWER MIXER</p>	<p>FLW009 £225 BASIN MONO</p>
		
<p>FLW045 £324 3 HOLE BATH FILLER</p>	<p>FLW047 £379 4 HOLE BATH SET</p>	<p>FLW049 £313 3 HOLE BASIN SET</p>



TAIT LEVER RANGE





			
<p>TTL001 £121</p>	<p>TTL003 £132</p>	<p>TTL009 £165</p>	<p>TTL009A £165</p>
<p>BASIN TAPS</p>	<p>BATH TAPS</p>	<p>BASIN MONO</p>	<p>SINGLE LEVER BASIN MONO</p>
			
<p>TTL005 £220</p>	<p>TTL007 £242</p>	<p>TTL049 £214</p>	
<p>BATH FILLER</p>	<p>BATH SHOWER MIXER</p>	<p>3 HOLE BASIN SET</p>	





TAIT CROSS RANGE







			
<p>TTX001 £121</p>	<p>TTX003 £132</p>	<p>TTX005 £220</p>	<p>TTX009 £165</p>
<p>BASIN TAPS</p>	<p>BATH TAPS</p>	<p>BATH FILLER</p>	<p>BASIN MONO</p>
			
<p>TTX007 £242</p>		<p>TTX049 £214</p>	
<p>BATH SHOWER MIXER</p>		<p>3 HOLE BASIN SET</p>	



LIU RANGE

AVAILABLE MAY 2008





		
LIU005 £133 BATH FILLER	LIU007 £160 BATH SHOWER MIXER	LIU009 £95 BASIN MONO





STIC RANGE





STC001 £126

BASIN TAPS



STC007 £263

BATH SHOWER MIXER



STC023 £263

BATH FILLER HIGH SPOUT



			
<p>STC003 £137</p>	<p>STC009 £176</p>	<p>STC011 £176</p>	<p>STC005 £242</p>
<p>BATH TAPS</p>	<p>BASIN MONO</p>	<p>BIDET MONO</p>	<p>BATH FILLER</p>
			
<p>STC013 £208</p>	<p>STC015 £219</p>	<p>STC021 £285</p>	
<p>3 HOLE BASIN SET</p>	<p>3 HOLE BATH FILLER</p>	<p>4 HOLE BATH SET</p>	
			
<p>STC025 £285</p>	<p>STC017 £208</p>		
<p>BATH SHOWER MIXER HIGH SPOUT</p>	<p>3 HOLE WALL MOUNTED BASIN SET</p>		
			
	<p>STC019 £219</p>		
	<p>3 HOLE WALL MOUNTED BATH FILLER</p>		

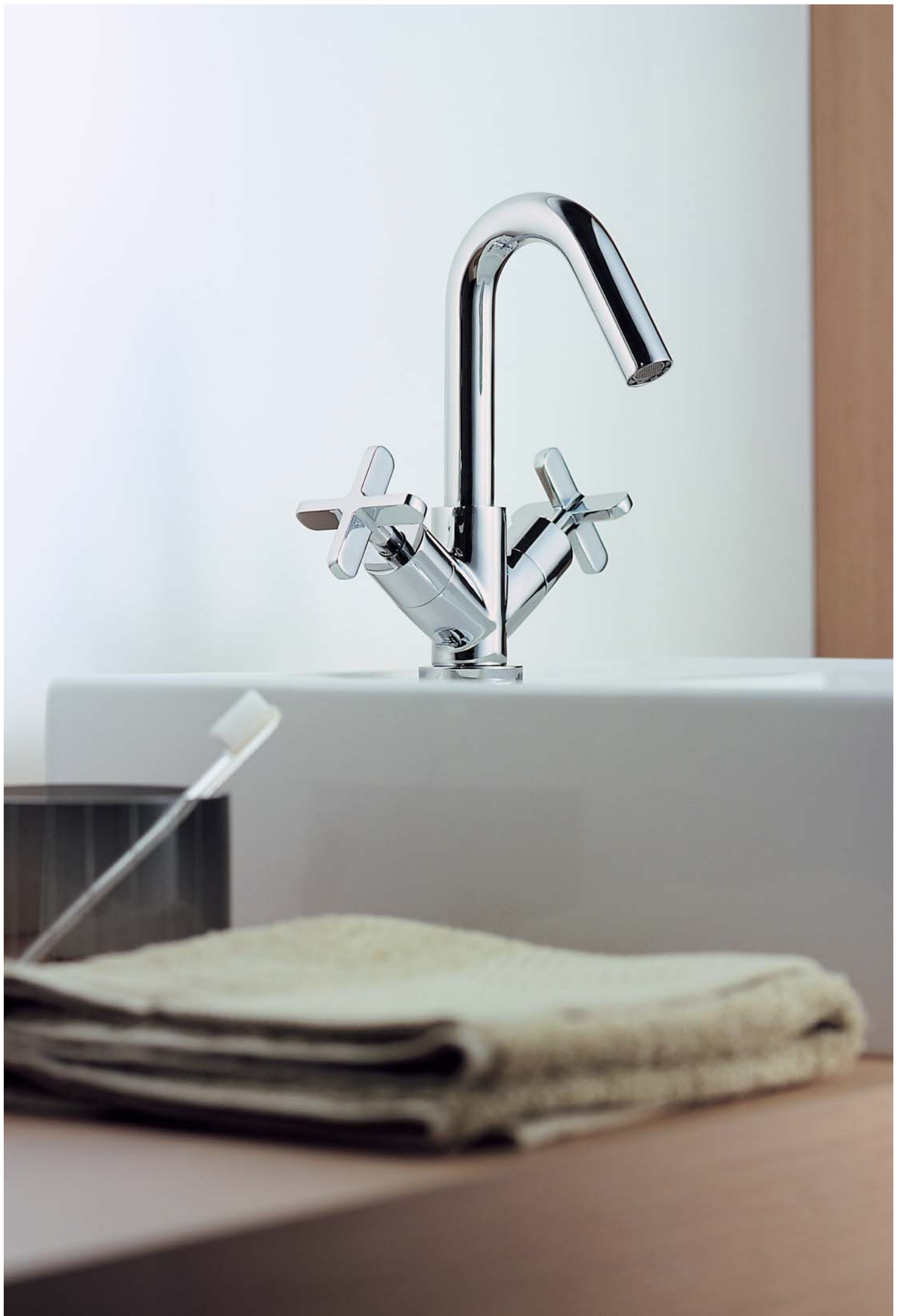

LOLI RANGE





LOL001 £126

BASIN TAPS



LOL007 £263

BATH SHOWER MIXER



LOL023 £263

BATH FILLER HIGH SPOUT

			
<p>LOL003 £137</p>	<p>LOL009 £176</p>	<p>LOL011 £176</p>	<p>LOL005 £242</p>
<p>BATH TAPS</p>	<p>BASIN MONO</p>	<p>BIDET MONO</p>	<p>BATH FILLER</p>
			
<p>LOL013 £208</p>	<p>LOL015 £219</p>	<p>LOL021 £285</p>	
<p>3 HOLE BASIN SET</p>	<p>3 HOLE BATH FILLER</p>	<p>4 HOLE BATH SET</p>	
			
<p>LOL025 £285</p>	<p>LOL017 £208</p>		
<p>BATH SHOWER MIXER HIGH SPOUT</p>	<p>3 HOLE WALL MOUNTED BASIN SET</p>		
	<p>LOL019 £219</p>		
<p>3 HOLE WALL MOUNTED BATH FILLER</p>	<p>HP</p>		





BLOX RANGE















		
<p>BLX009 £225</p>	<p>BLX005 £291</p>	<p>BLX007 £319</p>
<p>BASIN MONO</p>	<p>BATH FILLER</p>	<p>BATH SHOWER MIXER</p>
		
<p>BLX049 £324</p>	<p>BLX045 £313</p>	<p>BLX047 £379</p>
<p>3 HOLE BASIN SET</p>	<p>3 HOLE BATH FILLER</p>	<p>4 HOLE BATH SET</p>



ZOOM RANGE





			
<p>PLY001 £126</p>	<p>PLY003 £137</p>	<p>PLY009 £176</p>	<p>PLY017 £99</p>
<p>BASIN TAPS</p>	<p>BATH TAPS</p>	<p>BASIN MONO</p>	<p>CLOAKROOM TAP (S)</p>
			
<p>PLY019 £110</p>	<p>PLY013 £219</p>	<p>PLY015 £247</p>	
<p>CLOAKROOM TAP (L)</p>	<p>1 HOLE BATH FILLER</p>	<p>1 HOLE BATH SHOWER MIXER</p>	
			
<p>PLY005 £242</p>		<p>PLY007 £263</p>	
<p>BATH FILLER</p>		<p>BATH SHOWER MIXER</p>	





PRODUCT GUIDE

# CONTEMPORARY







ICE RANGE



CONTEMPORARY  
COLLECTION

ICE FALL RANGE  
LEVER HEAD



IFL001 £152

BASIN TAPS



IFL003 £163

BATH TAPS



IFL009 £196

BASIN MONO

	
<p>IFL005 £273</p>	<p>IFL007 £306</p>
<p>BATH FILLER</p>	<p>BATH SHOWER MIXER</p>
	
<p>IFL015 £306</p>	<p>IFL017 £328</p>
<p>BATH FILLER HIGH SPOUT</p>	<p>BATH SHOWER MIXER HIGH SPOUT</p>
	<div style="display: flex; justify-content: space-around;"> <div data-bbox="963 1637 1241 2096"> <p style="text-align: center;">NEW PRODUCT</p>  </div> <div data-bbox="1241 1637 1519 2096"> <p style="text-align: center;">NEW PRODUCT</p>  </div> </div>
<p>IFL019 (S) £185    IFL029 (M) £207    IFL039 (L) £218</p>	<p>IFL059 £143    IFL069 £159</p>
<p>FREESTANDING BASIN MONO</p>	<p>CLOAKROOM TAP (S)    CLOAKROOM TAP (L)</p>

CONTEMPORARY  
COLLECTION

ICE FALL RANGE  
CROSS HEAD



		
<p>IFX001 £152</p>	<p>IFX003 £163</p>	<p>IFX009 £207</p>
<p>BASIN TAPS</p>	<p>BATH TAPS</p>	<p>BASIN MONO</p>
		
<p>IFX005 £273</p>	<p>IFX007 £306</p>	
<p>BATH FILLER</p>	<p>BATH SHOWER MIXER</p>	
		
<p>IFX015 £306</p>	<p>IFX017 £328</p>	
<p>BATH FILLER HIGH SPOUT</p>	<p>BATH SHOWER MIXER HIGH SPOUT</p>	



CONTEMPORARY  
COLLECTION

ICE QUAD RANGE  
LEVER HEAD



ISL001 £152

BASIN TAPS



ISL003 £163

BATH TAPS



ISL009 £196

BASIN MONO

				
<p>ISL011 £196</p>	<p>ISL005 £273</p>	<p>ISL007 £306</p>		
<p>BIDET MONO</p>	<p>BATH FILLER</p>	<p>BATH SHOWER MIXER</p>		
				
<p>ISL015 £306</p>		<p>ISL017 £328</p>		
<p>BATH FILLER HIGH SPOUT</p>		<p>BATH SHOWER MIXER HIGH SPOUT</p>		
			<p>NEW PRODUCT</p> 	<p>NEW PRODUCT</p> 
<p>ISL019 (S) £185</p>	<p>ISL029 (M) £207</p>	<p>ISL039 (L) £218</p>	<p>ISL059 £143</p>	<p>ISL069 £159</p>
<p>FREESTANDING BASIN MONO</p>			<p>CLOAKROOM TAP (S)</p>	<p>CLOAKROOM TAP (L)</p>

CONTEMPORARY  
COLLECTION

ICE QUAD RANGE  
CROSS HEAD





		
<p>ISX001 £152</p>	<p>ISX003 £163</p>	<p>ISX009 £207</p>
<p>BASIN TAPS</p>	<p>BATH TAPS</p>	<p>BASIN MONO</p>
		
<p>ISX005 £273</p>	<p>ISX007 £306</p>	
<p>BATH FILLER</p>	<p>BATH SHOWER MIXER</p>	
		
<p>ISX015 £306</p>	<p>ISX017 £328</p>	
<p>BATH FILLER HIGH SPOUT</p>	<p>BATH SHOWER MIXER HIGH SPOUT</p>	



WAVE RANGE



CONTEMPORARY  
COLLECTION

WAVE RANGE



		
<p>RDL001 £115</p> <p>BASIN TAPS</p>	<p>RDL003 £142</p> <p>BATH TAPS</p>	<p>RDL009 £165</p> <p>BASIN MONO</p>
		
<p>RDL005 £232</p> <p>BATH FILLER</p>	<p>RDL007 £280</p> <p>BATH SHOWER MIXER</p>	
	<p>NEW PRODUCT</p> 	<p>NEW PRODUCT</p> 
<p>RDL015 £243</p> <p>BATH FILLER HIGH SPOUT</p>	<p>RDL059 £99</p> <p>CLOAKROOM TAP (S)</p>	<p>RDL069 £110</p> <p>CLOAKROOM TAP (L)</p>

CONTEMPORARY  
COLLECTION

WAVE RANGE







RDL017 £271

BATH SHOWER MIXER HIGH SPOUT

RDL019 (S) £131

RDL029 (M) £142

RDL039 (L) £159

FREESTANDING BASIN MONO



RDL013 £165

3 HOLE BASIN SET



RDL049 £263

4 HOLE BATH SET





SURF RANGE



CONTEMPORARY  
COLLECTION

SURF RANGE



			
<p>RDX001 £115</p>	<p>RDX003 £142</p>	<p>RDX009 £165</p>	<p>RDX005 £232</p>
<p>BASIN TAPS</p>	<p>BATH TAPS</p>	<p>BASIN MONO</p>	<p>BATH FILLER</p>
			
<p>RDX015 £243</p>	<p>RDX007 £280</p>	<p>RDX017 £271</p>	
<p>BATH FILLER HIGH SPOUT</p>	<p>BATH SHOWER MIXER</p>	<p>BATH SHOWER MIXER HIGH SPOUT</p>	
			
<p>RDX013 £165</p>	<p>RDX049 £263</p>		
<p>3 HOLE BASIN SET</p>	<p>4 HOLE BATH SET</p>		







QL RANGE



CONTEMPORARY  
COLLECTION

QL RANGE



		
QZ001 £99	QZ003 £110	QZ009 £110
BASIN TAPS	BATH TAPS	BASIN MONO
		
QZ005 £176	QZ007 £197	
BATH FILLER	BATH SHOWER MIXER	

CONTEMPORARY  
COLLECTION

ONYX RANGE



		
<p>OX009 £99</p>	<p>OX017 £99</p>	<p>OX005 £170</p>
<p>BASIN MONO</p>	<p>BIDET MONO</p>	<p>BATH SHOWER MIXER</p>
		
<p>OX001 £137</p>	<p>OX025 £197</p>	<p>OX027 £225</p>
<p>BATH FILLER</p>	<p>1 HOLE BATH FILLER</p>	<p>1 HOLE BATH SHOWER MIXER</p>

CONTEMPORARY  
COLLECTION

COMET RANGE





		
<p>CML005 £170 BATH FILLER</p>	<p>CML007 £203 BATH SHOWER MIXER</p>	<p>CML009 £110 BASIN MONO</p>

CONTEMPORARY  
COLLECTION

GEM RANGE









		
<p>GEM001 £197</p>	<p>GEM003 £219</p>	<p>GEM005 £99</p>
<p>BATH FILLER</p>	<p>BATH SHOWER MIXER</p>	<p>BASIN MONO</p>
		
<p>GEM007 £99</p>	<p>GEM015 £159</p>	<p>GEM017 £192</p>
<p>BIDET MONO</p>	<p>1 HOLE BATH FILLER</p>	<p>1 HOLE BATH SHOWER MIXER</p>

CONTEMPORARY  
COLLECTION

JET RANGE











		
<p>JET001 £197</p>	<p>JET003 £219</p>	<p>JET005 £99</p>
<p>BATH FILLER</p>	<p>BATH SHOWER MIXER</p>	<p>BASIN MONO</p>
		
<p>JET007 £99</p>	<p>JET015 £159</p>	<p>JET017 £192</p>
<p>BIDET MONO</p>	<p>1 HOLE BATH FILLER</p>	<p>1 HOLE BATH SHOWER MIXER</p>

CONTEMPORARY  
COLLECTION

SERIES C RANGE





			
<p>SCX001 £49</p>	<p>SCX003 £60</p>	<p>SCX009 £82</p>	<p>SCX011 £82</p>
<p>BASIN TAPS</p>	<p>BATH TAPS</p>	<p>BASIN MONO</p>	<p>BIDET MONO</p>
			
<p>SCX005 £126</p>	<p>SCX007 £148</p>		<p>SCX017 £137</p>
<p>BATH FILLER</p>	<p>BATH SHOWER MIXER</p>		<p>BATH FILLER HIGH SPOUT</p>

CONTEMPORARY  
COLLECTION

SERIES C RANGE





SCX019 £159

BATH SHOWER MIXER HIGH SPOUT



SCX049 £219

3 HOLE BASIN SET











SCX047 £253

4 HOLE BATH SET

CONTEMPORARY  
COLLECTION

SERIES D RANGE



			
<p>SDX001 £49</p>	<p>SDX003 £60</p>	<p>SDX009 £82</p>	<p>SDX011 £82</p>
<p>BASIN TAPS</p>	<p>BATH TAPS</p>	<p>BASIN MONO</p>	<p>BIDET MONO</p>
			
<p>SDX005 £126</p>	<p>SDX007 £148</p>		<p>SDX017 £137</p>
<p>BATH FILLER</p>	<p>BATH SHOWER MIXER</p>		<p>BATH FILLER HIGH SPOUT</p>



CONTEMPORARY  
COLLECTION

SERIES D RANGE







SDX019 £159

BATH SHOWER MIXER HIGH SPOUT



SDX049 £219

3 HOLE BASIN SET



SDX047 £253

4 HOLE BATH SET

CONTEMPORARY  
COLLECTION

SERIES F RANGE



			
<p>SFL001 £49</p>	<p>SFL003 £60</p>	<p>SFL009 £82</p>	<p>SFL011 £82</p>
<p>BASIN TAPS</p>	<p>BATH TAPS</p>	<p>BASIN MONO</p>	<p>BIDET MONO</p>
			
<p>SFL005 £126</p>	<p>SFL007 £148</p>	<p>SFL017 £137</p>	
<p>BATH FILLER</p>	<p>BATH SHOWER MIXER</p>	<p>BATH FILLER HIGH SPOUT</p>	
			
<p>SFL048 £197</p>	<p>SFL050 £225</p>		
<p>1 HOLE BATH FILLER</p>	<p>1 HOLE BATH SHOWER MIXER</p>		

CONTEMPORARY  
COLLECTION

SERIES F RANGE



	
<p>SFL019 £159 BATH SHOWER MIXER HIGH SPOUT</p>	<p>SER009 £115 SIDE LEVER MONO BASIN</p>
	 
<p>SFL049 £219 3 HOLE BASIN SET</p>	<p>SFL047 £253 4 HOLE BATH SET</p>
 	 
<p>SFL059 £77 CLOAKROOM TAP (S)</p>	<p>SFL069 £88 CLOAKROOM TAP (L)</p>











CONTEMPORARY  
COLLECTION

SERIES G RANGE





			
<p>SGL001 £49</p> <p>BASIN TAPS</p>	<p>SGL003 £60</p> <p>BATH TAPS</p>	<p>SGL009 £82</p> <p>BASIN MONO</p>	<p>SGL017 £137</p> <p>BATH FILLER HIGH SPOUT</p>
			
<p>SGL005 £126</p> <p>BATH FILLER</p>		<p>SGL007 £148</p> <p>BATH SHOWER MIXER</p>	
	<p>NEW PRODUCT</p>		
<p>SGL059 £77</p> <p>CLOAKROOM TAP (S)</p>	<p>NEW PRODUCT</p>		<p>SGL069 £88</p> <p>CLOAKROOM TAP (L)</p>

CONTEMPORARY  
COLLECTION

SERIES G RANGE



	
<p>SGL021 £159 BATH SHOWER MIXER HIGH SPOUT</p>	<p>SER009 £115 SIDE LEVER MONO BASIN</p>
	 
<p>SGL049 £219 3 HOLE BASIN SET</p>	<p>SGL047 £253 4 HOLE BATH SET</p>

CONTEMPORARY  
COLLECTION

SERIES P RANGE



			
<p>SPTH001 £49</p>	<p>SPTH003 £60</p>	<p>SPTH009 £82</p>	<p>SPTH011 £82</p>
<p>BASIN TAPS</p>	<p>BATH TAPS</p>	<p>BASIN MONO</p>	<p>BIDET MONO</p>
			
<p>SPTH013 £110</p>	<p>SPTH015 £197</p>	<p>SPTH005 £126</p>	
<p>DUAL LEVER MONO BASIN</p>	<p>1 HOLE BATH FILLER</p>	<p>BATH FILLER</p>	
		<p>SPTH017 £225</p>	<p>SPTH007 £148</p>
<p>1 HOLE BATH SHOWER MIXER</p>	<p>BATH SHOWER MIXER</p>		







PRODUCT GUIDE







# CLASSIC



CLASSIC  
COLLECTION

RENOIR RANGE







			
<p>REN001 £71</p>	<p>REN003 £82</p>	<p>REN009 £104</p>	<p>REN011 £104</p>
<p>BASIN TAPS</p>	<p>BATH TAPS</p>	<p>BASIN MONO</p>	<p>BIDET MONO</p>
			
<p>REN013 £115</p>		<p>REN007 £214</p>	
<p>3 HOLE BASIN SET</p>		<p>BATH SHOWER MIXER</p>	

CLASSIC  
COLLECTION

WESTMINSTER RANGE



		
WE001 £60 BASIN TAPS	WE005 £71 BATH TAPS	WE017 £93 BASIN MONO
		
WE021 £93 BIDET MONO	WE013 £192 BATH SHOWER MIXER	

CLASSIC  
COLLECTION

JUPITER RANGE







			
<p>JP001 £49</p> <p>BASIN TAPS</p>	<p>JP003 £71</p> <p>BATH TAPS</p>	<p>JP009 £82</p> <p>BASIN MONO</p>	<p>JP011 £82</p> <p>BIDET MONO</p>
			
<p>JP005 £104</p> <p>BATH FILLER</p>	<p>JP007 £148</p> <p>BATH SHOWER MIXER</p>	<p>JP013 £159</p> <p>3 HOLE BASIN SET</p>	

CLASSIC  
COLLECTION

RITZ RANGE



		
<p>RZ001 £38</p> <p>BASIN TAPS</p>	<p>RZ005 £49</p> <p>BATH TAPS</p>	<p>RZ017 £82</p> <p>BASIN MONO</p>
		
<p>RZ021 £82</p> <p>BIDET MONO</p>	<p>RZ013 £142</p> <p>BATH SHOWER MIXER</p>	



PRODUCT GUIDE

# FREESTANDING MONOS



ICE FALL LEVER RANGE



IFL019 £185

FREESTANDING BASIN MONO (S)

IFL029 £207

FREESTANDING BASIN MONO (M)



IFL039 £218

FREESTANDING BASIN MONO (L)



ICE QUAD LEVER RANGE



ISL019 £185

FREESTANDING BASIN MONO (S)



ISL029 £207

FREESTANDING BASIN MONO (M)



ISL039 £218

FREESTANDING BASIN MONO (L)

WAVE LEVER RANGE



RDL019 £131

FREESTANDING BASIN MONO (S)

RDL029 £142

FREESTANDING BASIN MONO (M)



RDL039 £159

FREESTANDING BASIN MONO (L)

## SERIES K RANGE



SK001 £82

FREESTANDING BASIN MONO (S)



SK003 £93

FREESTANDING BASIN MONO (M)



SK005 £104

FREESTANDING BASIN MONO (L)

SERIES N RANGE



SN001 £82

FREESTANDING BASIN MONO (S)

SN003 £93

FREESTANDING BASIN MONO (M)



SN005 £104

FREESTANDING BASIN MONO (L)

## SERIES RANGE







PRODUCT GUIDE

# BASICS



BASIC  
COLLECTION

ORION RANGE











		
<p>OR001 £75</p> <p>BASIN TAPS</p>	<p>OR003 £86</p> <p>BATH TAPS</p>	<p>OR009 £93</p> <p>BASIN MONO</p>
		
<p>OR011 £93</p> <p>BIDET MONO</p>	<p>OR005 £137</p> <p>BATH FILLER</p>	<p>OR015 £75</p> <p>SINGLE LEVER MONO BIDET</p>
		
<p>OR013 £75</p> <p>SINGLE LEVER MONO BASIN</p>	<p>OR007 £159</p> <p>BATH SHOWER MIXER</p>	

BASIC  
COLLECTION





























TITAN RANGE





		
<p>TT001 £75 BASIN TAPS</p>	<p>TT003 £86 BATH TAPS</p>	<p>TT009 £93 BASIN MONO</p>
		
<p>TT011 £93 BIDET MONO</p>	<p>TT013 £75 SINGLE LEVER BASIN MONO</p>	<p>TT005 £137 BATH FILLER</p>
		
<p>TT015 £75 SINGLE LEVER BIDET MONO</p>	<p>TT007 £159 BATH SHOWER MIXER</p>	

ALPHA RANGE

				
AL001 £24	AL005 £27	AL009 £96	AL013 £104	AL017 £74
BASIN TAPS	BATH TAPS	BATH FILLER	BATH SHOWER MIXER	BASIN MONO
				
AL021 £74	KIT127 £38	KIT121 £60	KIT133 £82	
BIDET MONO	SINK TAPS	DECK SINK MIXER	MONO SINK MIXER	
				
AL037 £28	AL039 £31	AL040 £103	AL041 £114	AL043 £79
BASIN TAPS	BATH TAPS	BATH FILLER	BATH SHOWER MIXER	BASIN MONO
				
AL045 £79	KIT131 £38	KIT123 £60	KIT141 £82	
BIDET MONO	SINK TAPS	DECK SINK MIXER	MONO SINK MIXER	
				
AL047 £28	AL051 £31	AL055 £103	AL059 £114	AL063 £79
BASIN TAPS	BATH TAPS	BATH FILLER	BATH SHOWER MIXER	BASIN MONO
				
AL067 £79	KIT129 £38	KIT125 £60	KIT143 £82	AL027 £107
BIDET MONO	SINK TAPS	DECK SINK MIXER	MONO SINK MIXER	SELF CLOSING TAPS (L)



AMBER +  
COSMOS

FEATURES  
MADE EASY



			
AMB001 £75	AMB005 £86	AMB009 £137	AMB013 £159
BASIN TAPS	BATH TAPS	BATH FILLER	BATH SHOWER MIXER
			
AMB017 £93	AMB021 £93		
BASIN MONO	BIDET MONO		

FEATURES  
MADE EASY



			
COS005 £75	COS007 £75	COS001 £108	COS003 £126
BASIN MONO	BIDET MONO	BATH FILLER	BATH SHOWER MIXER



PRODUCT GUIDE

# KITCHEN









KITCHEN  
COLLECTION

SINK MIXERS





			
KIT009 £170	KIT011 £170	KIT015 £159	KIT017 £214
MARSEILLE DUAL LEVER	ASTOR DUAL LEVER	ASCOT MONO	SYNCRO MONO
			
KIT019 £192	KIT021 £170	KIT023 £170	SER009 £115
ASTRO MONO	ROMA MONO	FLOW KITCHEN TAP	SIDE LEVER MONO BASIN

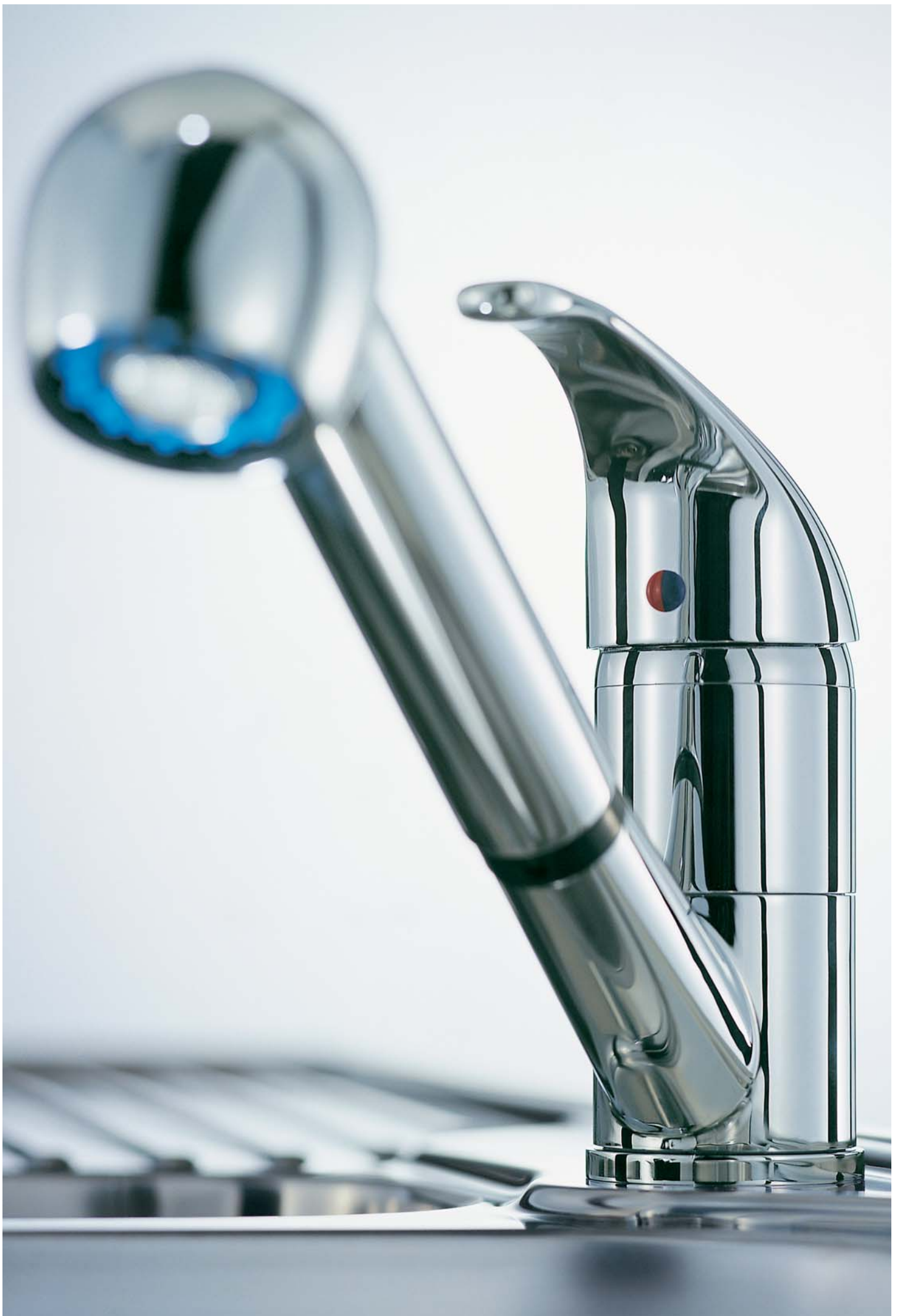

		
KIT001 £82	KIT005 £104	KIT007 £159
BRISTOL MONO	NOSTALGIA MONO	TITAN MONO PULLOUT H/SET
		
KIT013 £170	KIT041 £93	KIT091 £93
APOLLO MONO	COMO LEVER SINK MIXER	MODENA LEVER SINK MIXER

KITCHEN  
COLLECTION

SINK MIXERS AND TAPS



<p>KIT127 £38</p> <p>SINK TAPS</p>	<p>KIT121 £60</p> <p>DECK SINK MIXER</p>	<p>KIT133 £82</p> <p>MONO SINK MIXER</p>
<p>KIT131 £38</p> <p>SINK TAPS</p>	<p>KIT123 £60</p> <p>DECK SINK MIXER</p>	<p>KIT141 £82</p> <p>MONO SINK MIXER</p>
<p>KIT129 £38</p> <p>SINK TAPS</p>	<p>KIT125 £60</p> <p>DECK SINK MIXER</p>	<p>KIT143 £82</p> <p>MONO SINK MIXER</p>







PRODUCT GUIDE

# THERMOSTATIC SHOWERS



THERMOSTATIC SHOWERS  
COLLECTION

CONTEMPORARY CROSS RANGE

RECTANGLE DUAL CONTROLLED +  
EXPOSED CONCENTRIC







		
<p>KIT 1 THV056 £549</p>	<p>KIT 2 THV057 £481</p>	
<p>Thermostatic 3/4 built-in mixer with solid brass plate, wall elbow &amp; contemporary slide kit with microphone handset</p>	<p>Thermostatic 3/4 built-in mixer with solid brass plate &amp; contemporary concealed shower arm with 6" rose &amp; swivel knuckle</p>	
		
<p>KIT 3 THV058 £594</p>	<p>KIT 4 THV059 £692</p>	<p>KIT 5 THV060 £677</p>
<p>Thermostatic exposed concentric mixer &amp; contemporary slide kit with microphone handset</p>	<p>Thermostatic exposed concentric mixer &amp; contemporary fixed riser with 6" head (disc) with diverter &amp; slider</p>	<p>Thermostatic exposed concentric mixer &amp; contemporary fixed riser with 6" rose &amp; swivel knuckle</p>

THERMOSTATIC SHOWERS  
COLLECTION

CONTEMPORARY CROSS RANGE

CONCEALED CONCENTRIC BRASS PLATE +  
THERMO BAR DUAL OUTLET



			
<p>KIT 6 THV061 £680</p>	<p>KIT 7 THV062 £612</p>	<p>KIT 8 THV069 £400</p>	<p>KIT 8 THV070 £474</p>
<p>Thermostatic concealed concentric mixer with brass plate, wall elbow &amp; contemporary slide kit with microphone handset</p>	<p>Thermostatic concealed concentric mixer with brass plate &amp; contemporary concealed shower arm with 6" rose &amp; swivel knuckle</p>	<p>Thermo bar mixer with single outlet &amp; contemporary slide kit, microphone handset with 6" head, swivel knuckle &amp; slider</p>	<p>Thermo bar mixer with dual outlet &amp; contemporary fixed riser with 6" head slider</p>



THERMOSTATIC SHOWERS  
COLLECTION

CONTEMPORARY LEVER RANGE

RECTANGLE DUAL LEVER +  
EXPOSED CONCENTRIC









		
<p>KIT 1 THV049 £549</p>	<p>KIT 2 THV050 £481</p>	
<p>Thermostatic 3/4 built-in mixer with solid brass plate, wall elbow &amp; contemporary slide kit with microphone handset</p>	<p>Thermostatic 3/4 built-in mixer with solid brass plate &amp; contemporary concealed shower arm with 6" rose &amp; swivel knuckle</p>	
		
<p>KIT 3 THV051 £594</p>	<p>KIT 4 THV052 £692</p>	<p>KIT 5 THV053 £677</p>
<p>Thermostatic exposed concentric mixer &amp; contemporary slide kit with microphone handset</p>	<p>Thermostatic exposed concentric mixer &amp; contemporary fixed riser with 6" head (disc) with diverter &amp; slider</p>	<p>Thermostatic exposed concentric mixer &amp; contemporary fixed riser with 6" rose &amp; swivel knuckle</p>

THERMOSTATIC SHOWERS  
COLLECTION

CONTEMPORARY LEVER RANGE

CONCEALED CONCENTRIC BRASS PLATE +  
THERMO BAR DUAL OUTLET



			
<p>KIT 6 THV054 £680</p>	<p>KIT7 THV055 £612</p>	<p>KIT 8 THV065 £400</p>	<p>KIT 9 THV066 £474</p>
<p>Thermostatic concealed concentric mixer with brass plate, wall elbow &amp; contemporary slide kit with microphone handset</p>	<p>Thermostatic concealed concentric mixer with brass plate &amp; contemporary concealed shower arm with 6" rose &amp; swivel knuckle</p>	<p>Thermo bar mixer with single outlet &amp; contemporary slide kit with microphone handset</p>	<p>Thermo bar mixer with dual outlet &amp; contemporary fixed riser with 6" head slider</p>

THERMOSTATIC SHOWERS  
COLLECTION

TRADITIONAL RANGE

RECTANGLE DUAL LEVER +  
EXPOSED CONCENTRIC



		
<p>KIT 1 TH-V032 £527</p>	<p>KIT 2 TH-V036 £481</p>	
<p>Thermostatic 3/4 built-in mixer with solid brass plate (rectangle dual lever), wall elbow (solid brass) &amp; traditional slide kit</p>	<p>Thermostatic 3/4 built-in mixer with solid brass plate (rectangle dual lever) &amp; traditional concealed shower arm with 6" rose &amp; swivel knuckle</p>	
		
<p>KIT 3 TH-V034 £572</p>	<p>KIT 4 TH-V038 £692</p>	<p>KIT 5 TH-V039 £677</p>
<p>Thermostatic exposed concentric mixer &amp; traditional slide rail kit</p>	<p>Thermostatic exposed concentric mixer &amp; traditional fixed riser 6" head with diverter &amp; slider</p>	<p>Thermostatic exposed concentric mixer &amp; traditional fixed riser with 6" rose &amp; swivel knuckle</p>







THERMOSTATIC SHOWERS  
COLLECTION

TRADITIONAL RANGE

CONCEALED CONCENTRIC BRASS PLATE +  
THERMO BAR DUAL OUTLET





			
<p>KIT 6 THV040 £680</p>	<p>KIT 7 THV041 £612</p>	<p>KIT 8 THV064 £474</p>	<p>THV063 £378</p>
<p>Thermostatic concealed concentric mixer with brass plate, wall elbow &amp; traditional slide kit</p>	<p>Thermostatic concealed concentric mixer with brass plate &amp; traditional concealed shower arm with 6" rose &amp; swivel knuckle</p>	<p>Thermo bar valve with dual outlet &amp; traditional fixed riser with 6" head with slider</p>	<p>Thermo bar mixer with single outlet &amp; traditional slide rail kit</p>

THERMOSTATIC SHOWERS  
COLLECTION

BASIC RANGE

SOLO THERMOSTATIC BAR VALVE +  
SLIDE RAIL KIT







PRODUCT GUIDE

# ACCESSORIES



ACCESSORIES  
COLLECTION





Freestanding Stand Pipes fit most ranges - call for details.

		
ACC021 £11	ACC024 £46	ACC032C £10
DELUXE BASIN WASTE	SQUARE BASIN WASTE	DELUXE BATH WASTE
		
ACC033 £11	ACC035 £74	ACC039 £36
TIDY BATH WASTE	SQUARE BATH WASTE & OVERFLOW	BATH POP-UP WASTE
		
ACC047 £11	ACC051 £15	ACC053 £33
SHOWER WASTE	CLICK-CLACK BASIN WASTE	FLIP PLUG BASIN WASTE
		
ACC061 £15	ACC065 £17	ACC089 £210
STANDARD WEDGE LEVER	DELUXE WEDGE LEVER	FREESTANDING STAND PIPES

# ACCESSORIES COLLECTION

# POINT-OF-SALE DISPLAY STAND

NEW  
PRODUCT

Our new stand requires no assembly, simply hook on the shelves and hold up to eight products from the Mayfair portfolio. Comes complete with taps, graphics and brochures.

FITS:  
BATH FILLERS  
MONO BASIN MIXERS  
BASIN TAPS  
BATH TAPS  
KITCHEN TAPS

POS002  
Please contact  
for details.



	
ACC093 £21	ACC095 £90
TRADITIONAL BOTTLE TRAP	SQUARE BOTTLE TRAP
	
ACC097 £74	
CONTEMPORARY BOTTLE TRAP	
	
ACC105 £5	
CONTEMPORARY WALL BRACKET	

PRODUCT GUIDE

# TECHNICAL INFORMATION

## TECHNICAL INFORMATION

### FLOW RANGE

- 01 FLW005 BATH FILLER
- 02 FLW007 BATH SHOWER MIXER
- 03 FLW009 MONO BASIN
- 04 FLW045 3 HOLE BASIN SET
- 05 FLW047 4 HOLE BATH SET
- 06 FLW049 3 HOLE BASIN SET

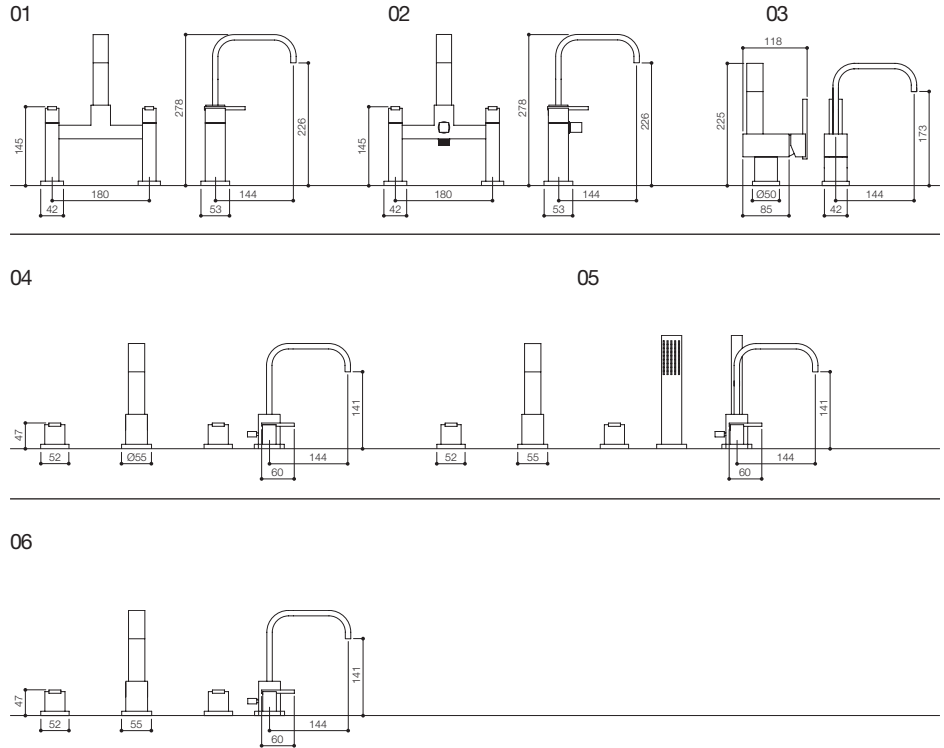

### TAIT LEVER RANGE

- 01 TTL001 BASIN TAPS
- 02 TTL003 BATH TAPS
- 03 TTL005 BATH FILLER
- 04 TTL007 BATH SHOWER MIXER
- 05 TTL009 BASIN MONO
- 06 TTL009A SINGLE LEVER BASIN MONO
- 07 TTL049 3 HOLE BASIN SET

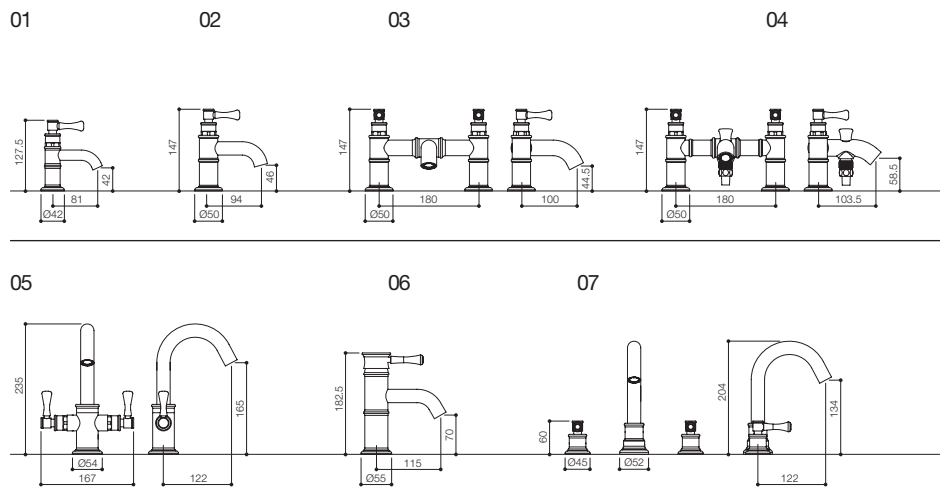

TAIT CROSS RANGE

- 01 TTX001 BASIN TAPS
- 02 TTX003 BATH TAPS
- 03 TTX005 BATH FILLER
- 04 TTX007 BATH SHOWER MIXER
- 05 TTX009 BASIN MONO
- 06 TTX049 3 HOLE BASIN SET

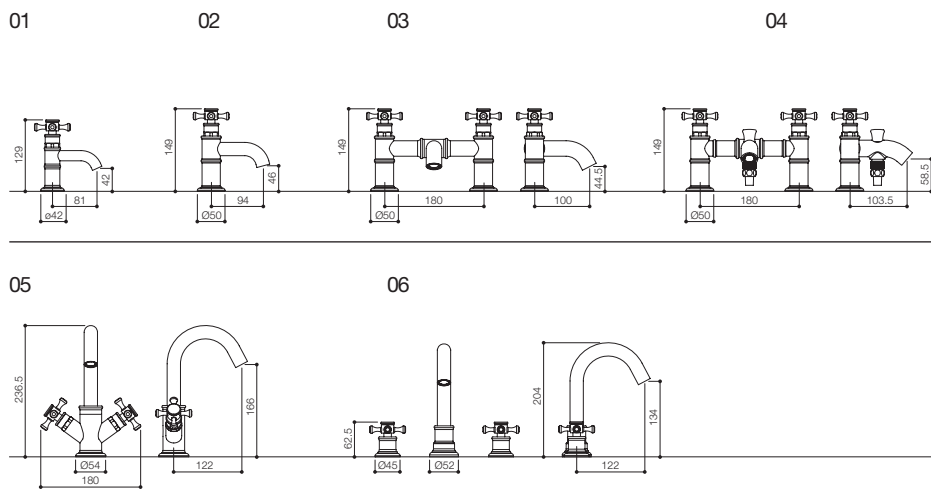

LIU RANGE

- 01 LIU005 BATH FILLER
- 02 LIU007 BATH SHOWER MIXER
- 03 LIU009 BASIN MONO

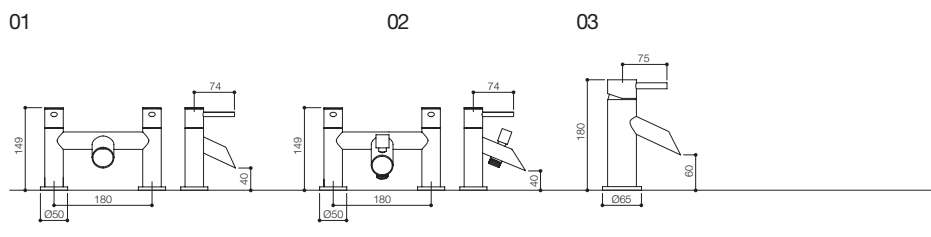

## TECHNICAL INFORMATION

### STIC RANGE

- 01 STC001 BASIN TAPS
- 02 STC003 BATH TAPS
- 03 STC009 BASIN MONO
- 04 STC011 BIDET MONO
- 05 STC005 BATH FILLER
- 06 STC007 BATH SHOWER MIXER
- 07 STC013 3 HOLE BASIN SET
- 08 STC015 3 HOLE BATH SET
- 09 STC021 4 HOLE BATH SET
- 10 STC023 BATH FILLER HIGH SPOUT
- 11 STC025 BSM HIGH SPOUT
- 12 STC017 3 HOLE WALL MOUNT BASIN SET
- 13 STC019 3 HOLE WALL MOUNT BATH FILLER

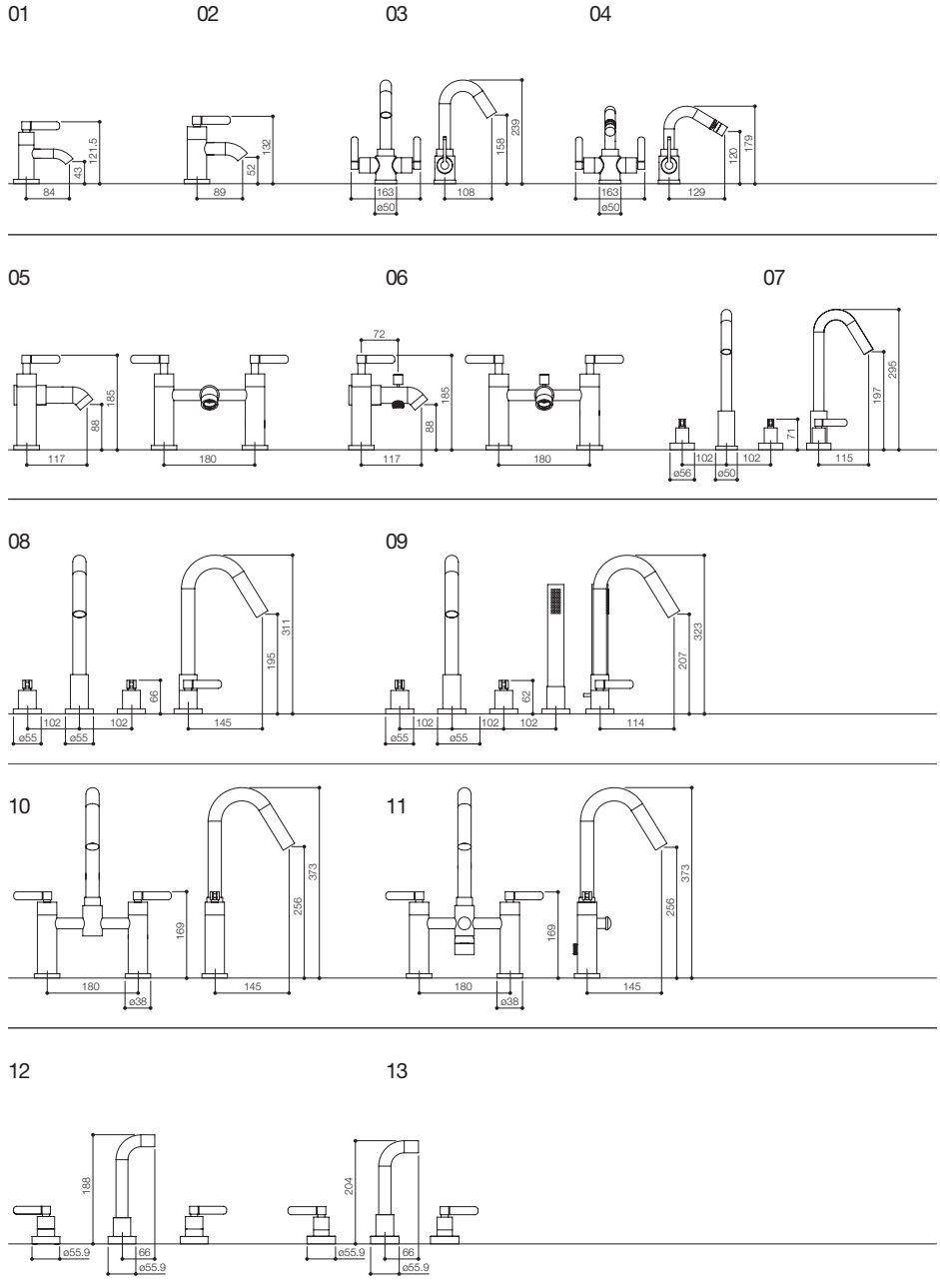





## TECHNICAL INFORMATION

### BLOX RANGE

- 01 BLX009 BASIN MONO
- 02 BLX005 BATH FILLER
- 03 BLX007 BATH SHOWER MIXER
- 04 BLX049 3 HOLE BASIN SET
- 05 BLX045 3 HOLE BATH SET
- 06 BLX047 4 HOLE BATH SET

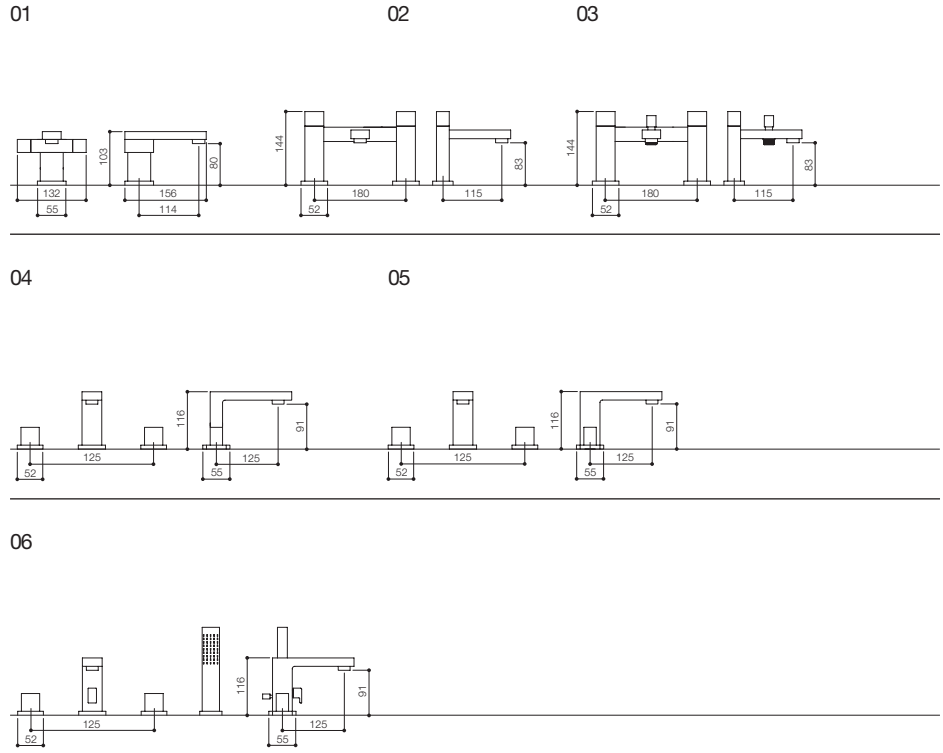

### ZOOM RANGE

- 01 PLY001 BASIN TAPS
- 02 PLY003 BATH TAPS
- 03 PLY009 MONO BASIN
- 04 PLY017 CLOAKROOM TAP (S)
- 05 PLY019 CLOAKROOM TAP (L)
- 06 PLY013 1 HOLE BATH FILLER
- 07 PLY015 1 HOLE BSM
- 08 PLY005 BATH FILLER
- 09 PLY007 BATH SHOWER MIXER

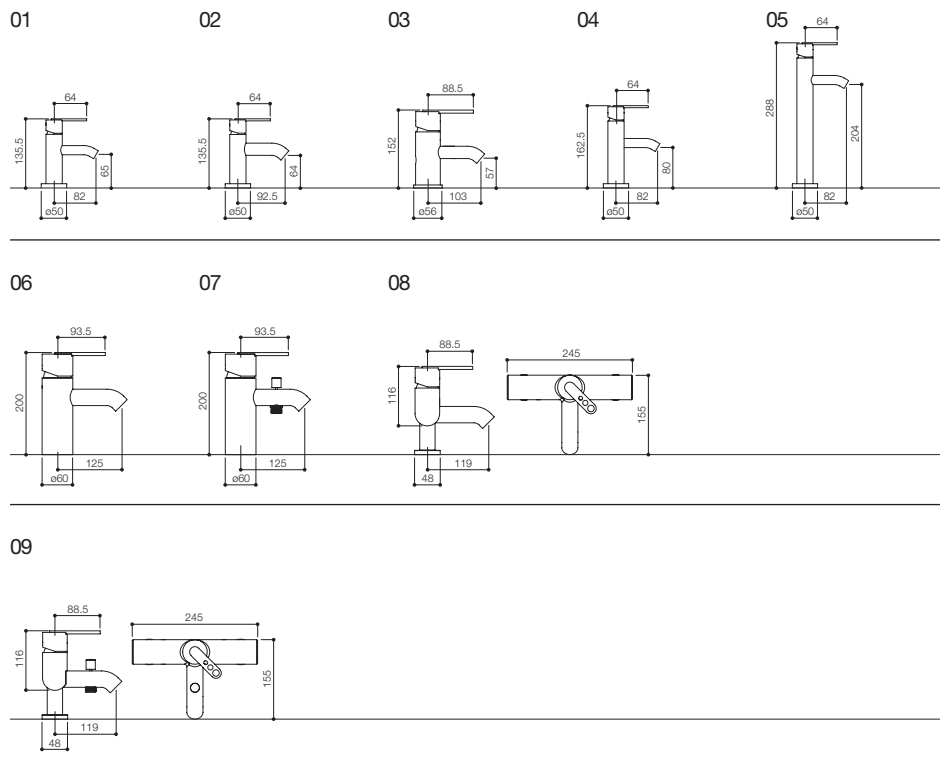

ICE RANGE  
FALL LEVER

- 01 IFL001 BASIN TAPS
- 02 IFL003 BATH TAPS
- 03 IFL005 BATH FILLER
- 04 IFL007 BATH SHOWER MIXER
- 05 IFL009 MONO BASIN
- 06 IFL015 BATH FILLER HIGH SPOUT
- 07 IFL017 BSM HIGH SPOUT
- 08 IFL019 FREESTANDING MIXER (S)
- 09 IFL029 FREESTANDING MIXER (M)
- 10 IFL039 FREESTANDING MIXER (L)
- 11 IFL059 CLOAKROOM TAP (S)
- 12 IFL069 CLOAKROOM TAP (L)

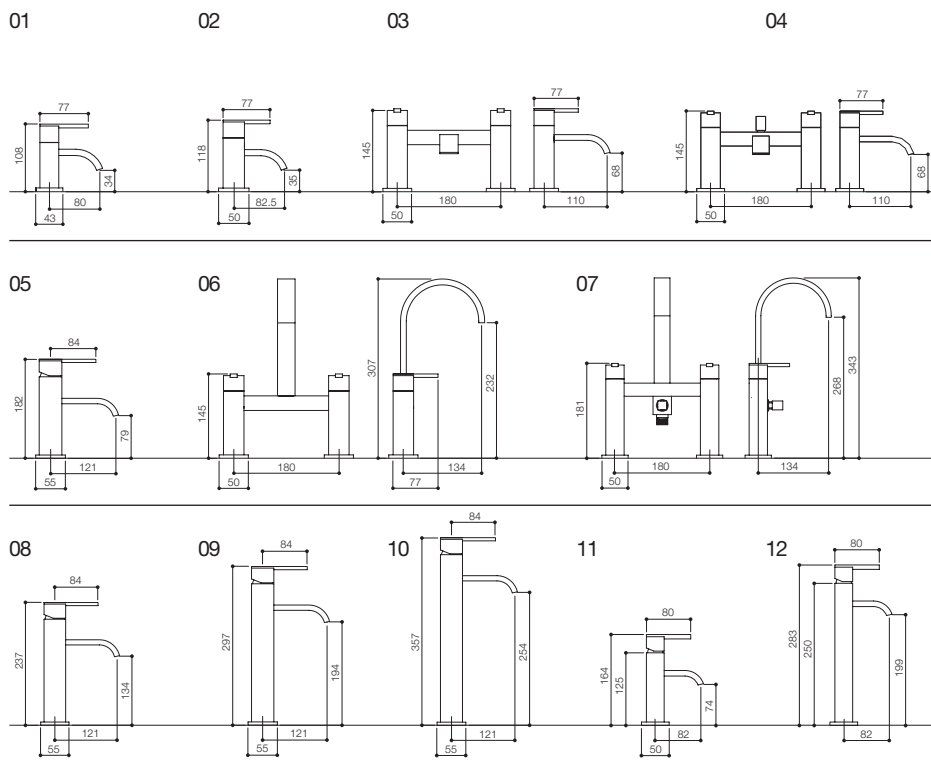

ICE RANGE  
FALL CROSS

- 01 IFX001 BASIN TAPS
- 02 IFX003 BATH TAPS
- 03 IFX005 BATH FILLER
- 04 IFX007 BATH SHOWER MIXER
- 05 IFX009 MONO BASIN
- 06 IFX015 BATH FILLER HIGH SPOUT
- 07 IFX017 BSM HIGH SPOUT

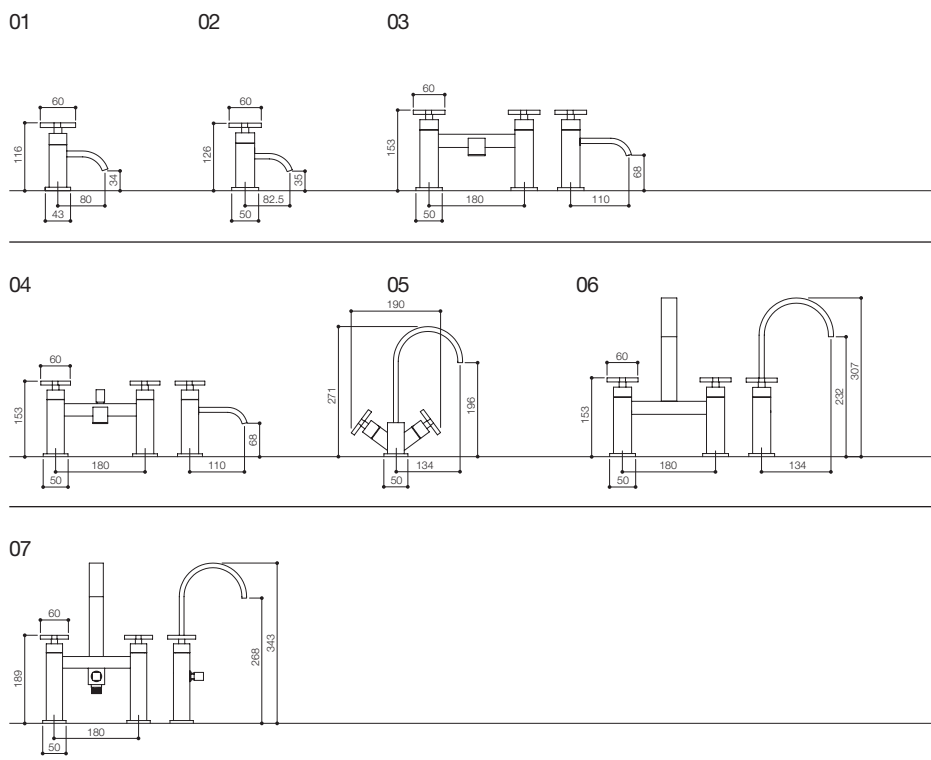

## TECHNICAL INFORMATION

### ICE RANGE QUAD LEVER

- 01 ISL001 BASIN TAPS
- 02 ISL003 BATH TAPS
- 03 ISL005 BATH FILLER
- 04 ISL007 BSM
- 05 ISL009 MONO BASIN
- 06 ISL011 MONO BIDET
- 07 ISL015 BATH FILLER HIGH SPOUT
- 08 ISL017 BSM HIGH SPOUT
- 09 ISL019 FREESTANDING MIXER (S)
- 10 ISL029 FREESTANDING MIXER (M)
- 11 ISL039 FREESTANDING MIXER (L)
- 12 ISL059 CLOAKROOM TAP (S)
- 13 ISL069 CLOAKROOM TAP (L)

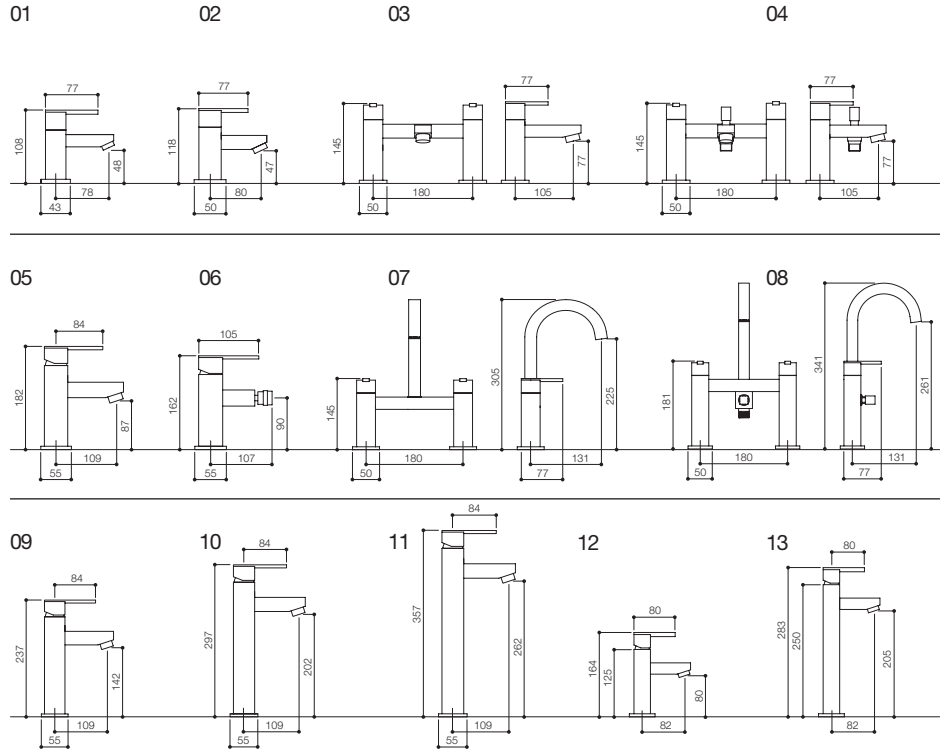

### ICE RANGE QUAD CROSS

- 01 ISX001 BASIN TAPS
- 02 ISX003 BATH TAPS
- 03 ISX005 BATH FILLER
- 04 ISX007 BSM
- 05 ISX009 MONO BASIN
- 06 ISX015 BATH FILLER HIGH SPOUT
- 07 ISX017 BSM HIGH SPOUT

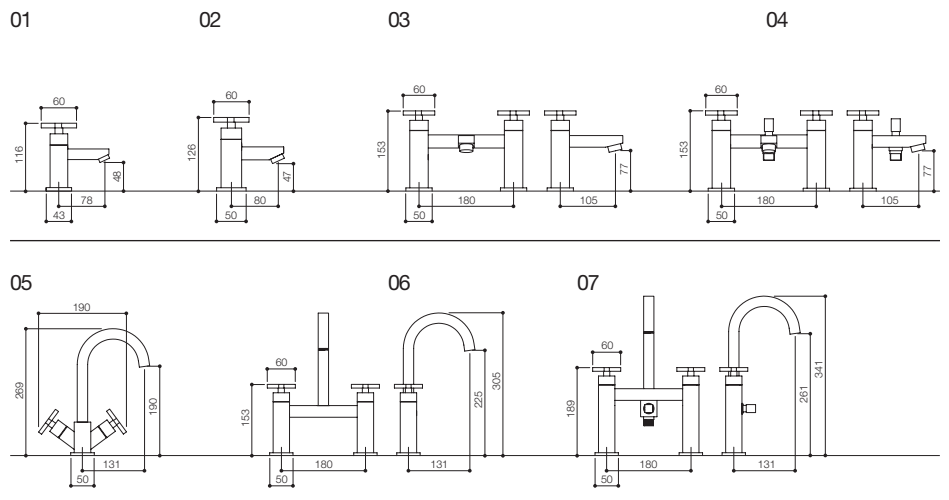

WAVE RANGE

- 01 RDL001 BASIN TAPS
- 02 RDL003 BATH TAPS
- 03 RDL005 BATH FILLER
- 04 RDL007 BATH SHOWER MIXER
- 05 RDL009 MONO BASIN
- 06 RDL015 BATH FILLER HIGH SPOUT
- 07 RDL017 BATH SHOWER MIXER HIGH SPOUT
- 08 RDL019 FREESTANDING MONO (S)
- 09 RDL029 FREESTANDING MONO (M)
- 10 RDL039 FREESTANDING MONO (L)
- 11 RDL013 3 HOLE BASIN SET
- 12 RDL049 4 HOLE BATH SET
- 13 RDL059 CLOAKROOM TAP (S)
- 14 RDL069 CLOAKROOM TAP (L)

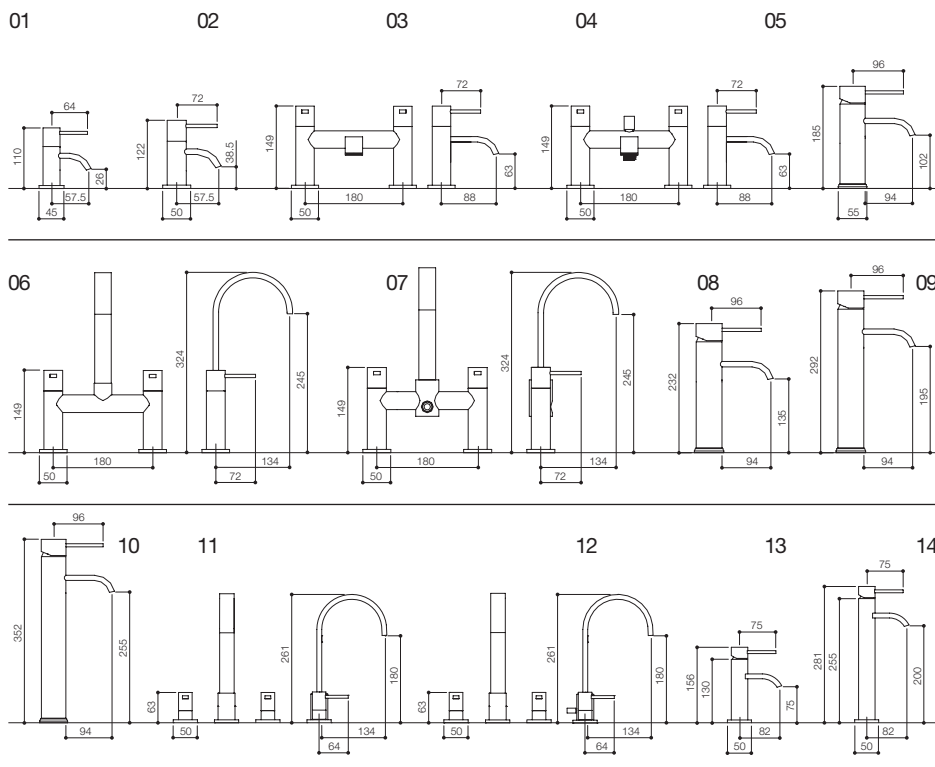

SURF RANGE

- 01 RDX001 BASIN TAPS
- 02 RDX003 BATH TAPS
- 03 RDX009 MONO BASIN
- 04 RDX005 BATH FILLER
- 05 RDX007 BATH SHOWER MIXER
- 06 RDX015 BATH FILLER HIGH SPOUT
- 07 RDX017 BATH SHOWER MIXER HIGH SPOUT
- 08 RDX013 3 HOLE BASIN SET
- 09 RDX049 4 HOLE BATH SET

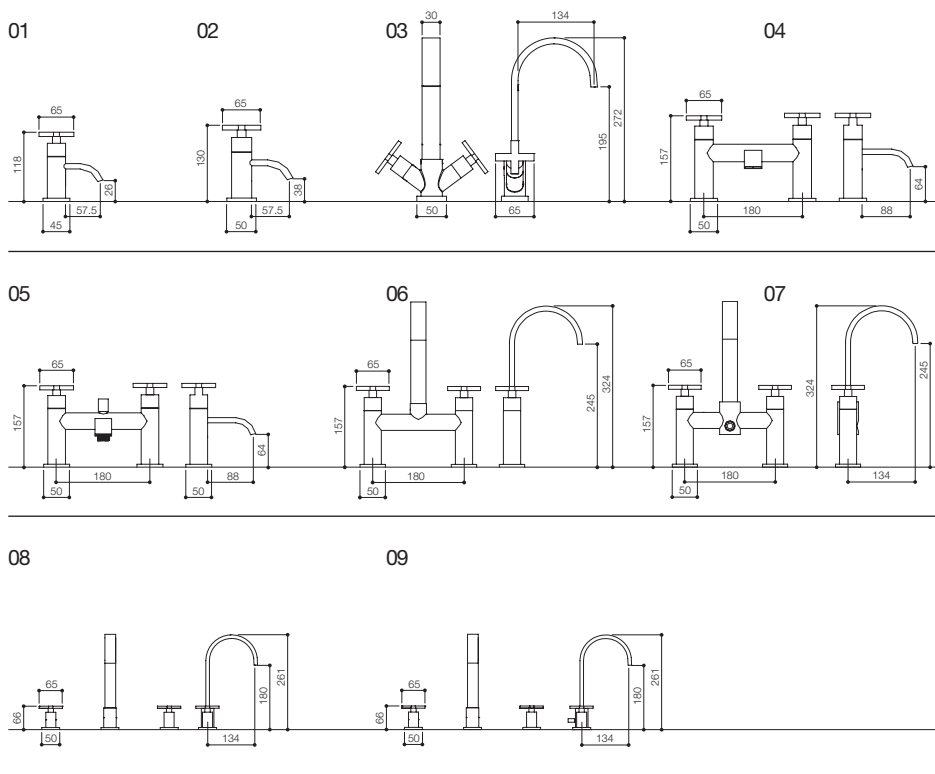

## TECHNICAL INFORMATION

### QL RANGE

- 01 QZ001 BASIN TAPS
- 02 QZ003 BATH TAPS
- 03 QZ009 MONO BASIN
- 04 QZ005 BATH FILLER
- 05 QZ007 BSM

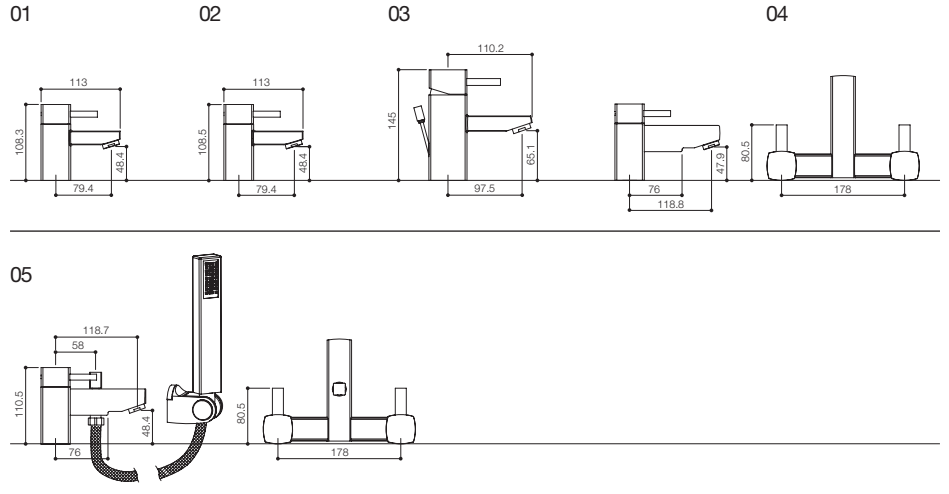

### ONYX RANGE

- 01 OX009 MONO BASIN
- 02 OX017 MONO BIDET
- 03 OX005 BSM
- 04 OX001 BATH FILLER
- 05 OX025 1 HOLE BATH FILLER
- 06 OX027 1 HOLE BSM

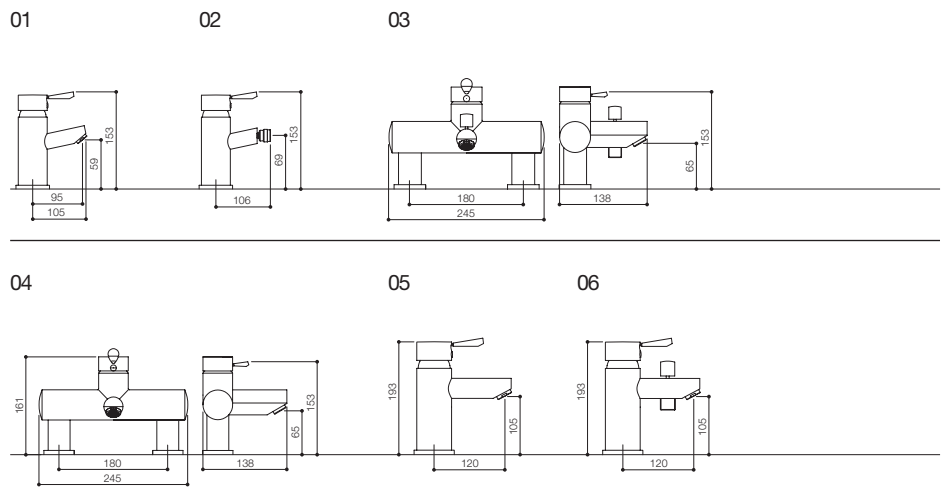



COMET RANGE

- 01 CML005 BATH FILLER
- 02 CML007 BATH SHOWER MIXER
- 03 CML009 MONO BASIN

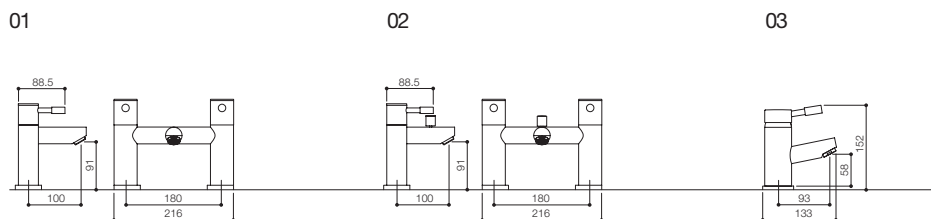

GEM RANGE

- 01 GEM001 BATH FILLER
- 02 GEM003 BSM
- 03 GEM005 MONO BASIN
- 04 GEM007 MONO BIDET
- 05 GEM015 1 HOLE BATH FILLER
- 06 GEM017 1 HOLE BSM

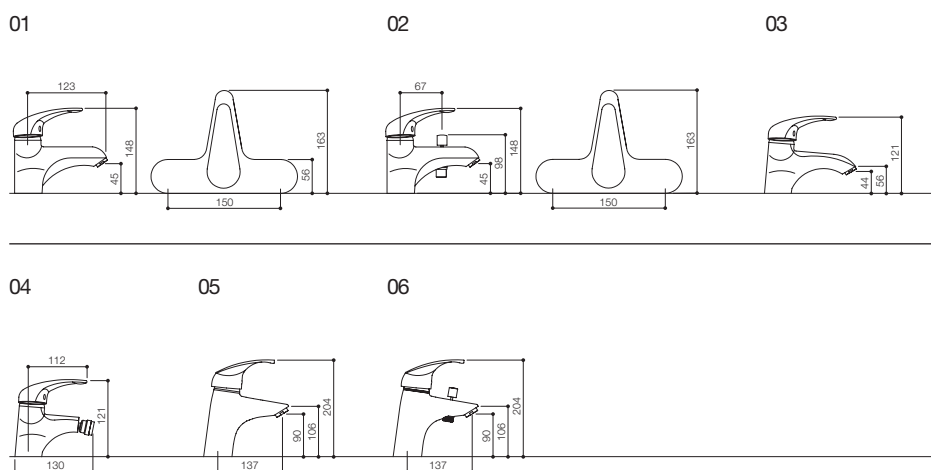

JET RANGE

- 01 JET001 BATH FILLER
- 02 JET003 BSM
- 03 JET005 MONO BASIN
- 04 JET007 MONO BIDET
- 05 JET015 1 HOLE BATH FILLER
- 06 JET017 1 HOLE BSM

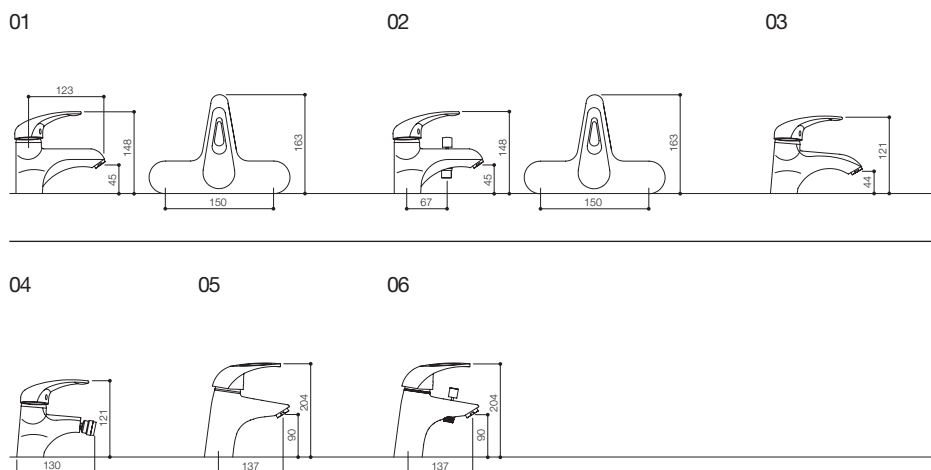

## TECHNICAL INFORMATION

### SERIES C RANGE

- 01 SCX001 BASIN TAPS
- 02 SCX003 BATH TAPS
- 03 SCX009 MONO BASIN
- 04 SCX011 MONO BIDET
- 05 SCX005 BATH FILLER
- 06 SCX007 BSM
- 07 SCX017 BATH FILLER HIGH SPOUT
- 08 SCX019 BSM HIGH SPOUT
- 09 SCX049 3 HOLE BASIN SET
- 10 SCX047 4 HOLE BATH SET

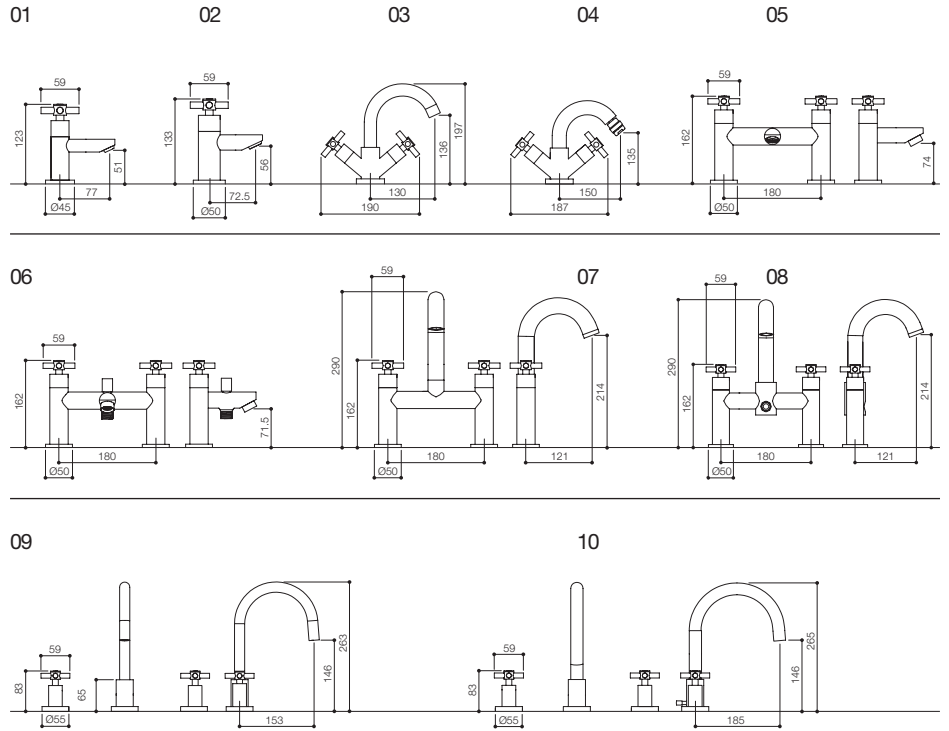

### SERIES D RANGE

- 01 SDX001 BASIN TAPS
- 02 SDX003 BATH TAPS
- 03 SDX009 MONO BASIN
- 04 SDX011 MONO BIDET
- 05 SDX005 BATH FILLER
- 06 SDX007 BSM
- 07 SDX017 BATH FILLER HIGH SPOUT
- 08 SDX019 BSM HIGH SPOUT
- 09 SDX049 3 HOLE BASIN SET
- 10 SDX047 4 HOLE BATH SET

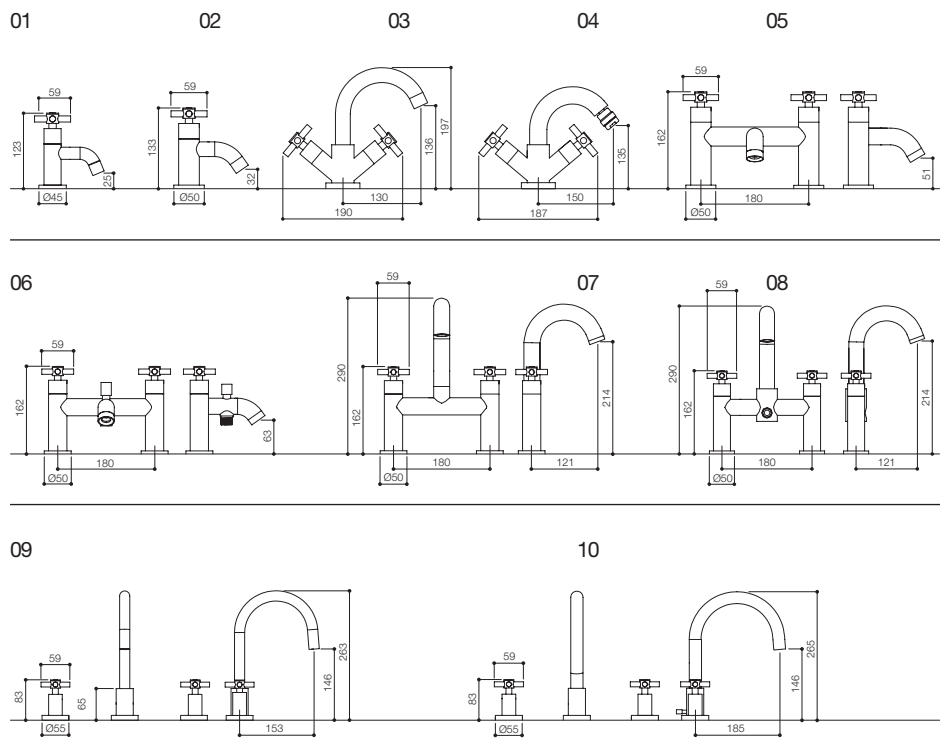

SERIES F RANGE

- 01 SFL001 BASIN TAPS
- 02 SFL003 BATH TAPS
- 03 SFL009 MONO BASIN
- 04 SFL011 MONO BIDET
- 05 SFL005 BATH FILLER
- 06 SFL007 BSM
- 07 SFL017 BATH FILLER HIGH SPOUT
- 08 SFL049 1 HOLE BATH FILLER
- 09 SFL050 1 HOLE BSM
- 10 SFL019 BSM HIGH SPOUT
- 11 SER009 SIDE LEVER MONO BASIN
- 12 SFL049 3 HOLE BASIN SET
- 13 SFL047 4 HOLE BATH SET
- 14 SFL059 CLOAKROOM TAP (S)
- 15 SFL069 CLOAKROOM TAP (L)

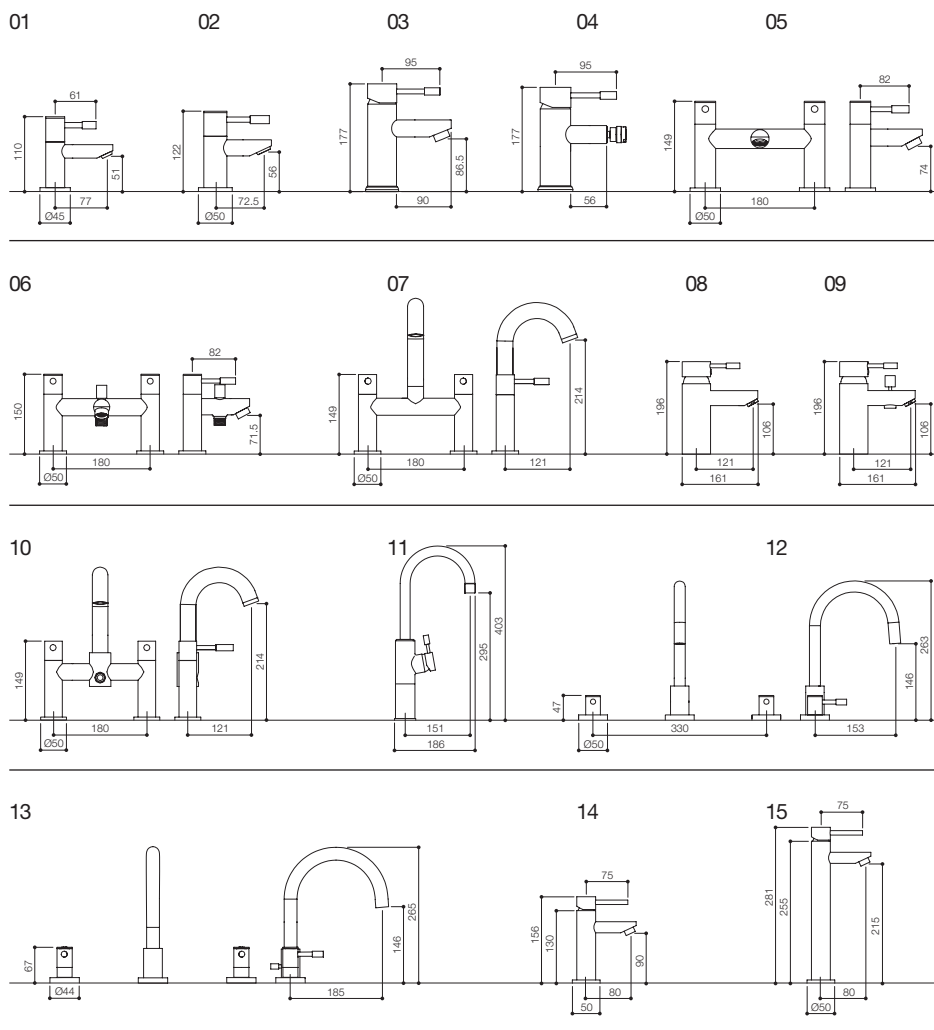

## TECHNICAL INFORMATION

### SERIES G RANGE

- 01 SGL001 BASIN TAPS
- 02 SGL003 BATH TAPS
- 03 SGL009 MONO BASIN
- 04 SER009 SIDE LEVER MONO BASIN
- 05 SGL005 BATH FILLER
- 06 SGL007 BSM
- 07 SGL017 BATH FILLER HIGH SPOUT
- 08 SGL019 BSM HIGH SPOUT
- 09 SGL049 3 HOLE BASIN SET
- 10 SGL047 4 HOLE BATH SET
- 11 SGL059 CLOAKROOM TAP (S)
- 12 SGL069 CLOAKROOM TAP (L)

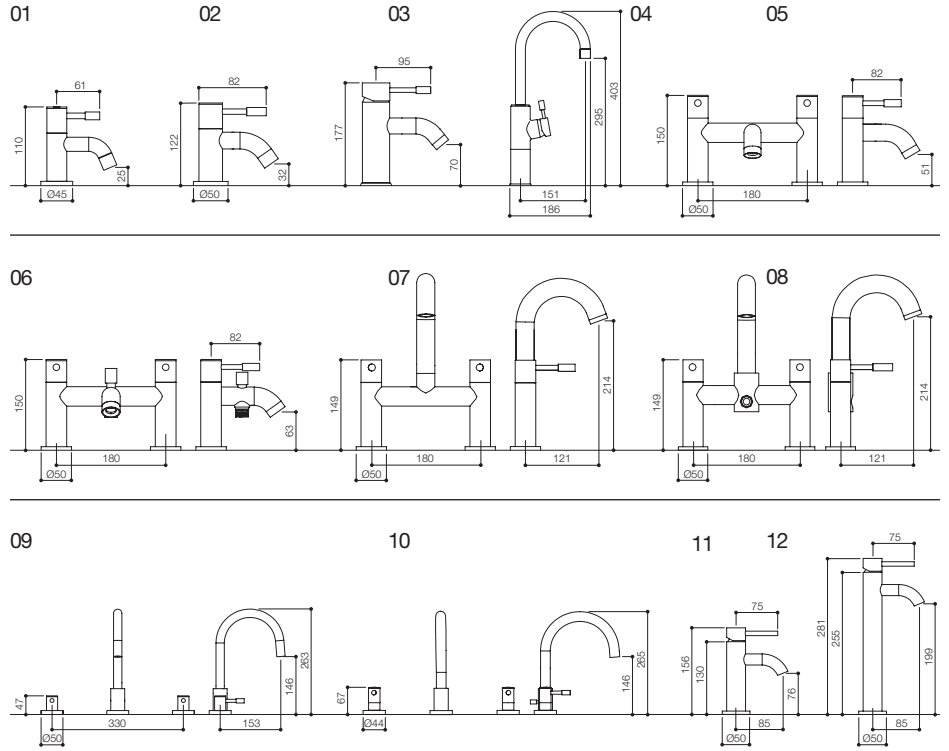

### SERIES P RANGE

- 01 SPTH001 BASIN TAPS
- 02 SPTH003 BATH TAPS
- 03 SPTH009 MONO BASIN
- 04 SPTH011 MONO BIDET
- 05 SPTH005 BATH FILLER
- 06 SPTH007 BSM
- 07 SPTH013 DUAL LEVER MONO BASIN
- 08 SPTH015 1 HOLE BATH FILLER
- 09 SPTH017 1 HOLE BSM

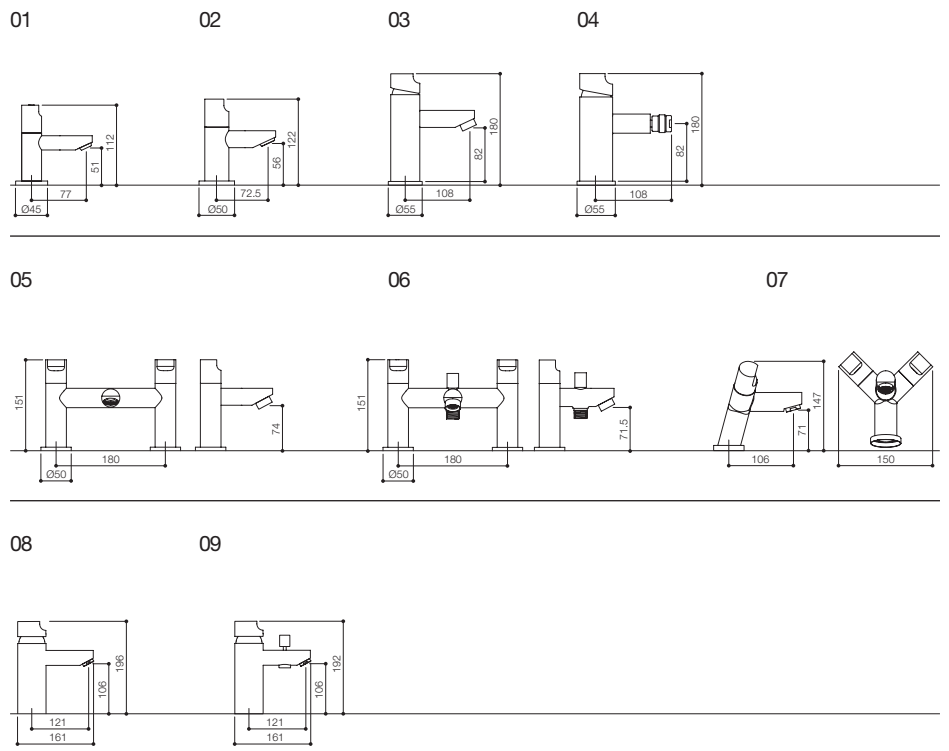

RENOIR RANGE

- 01 REN001 BASIN TAPS
- 02 REN003 BATH TAPS
- 03 REN009 BATH SHOWER MIXER
- 04 REN011 MONO BASIN
- 05 REN013 MONO BIDET
- 06 REN007 3 HOLE BASIN

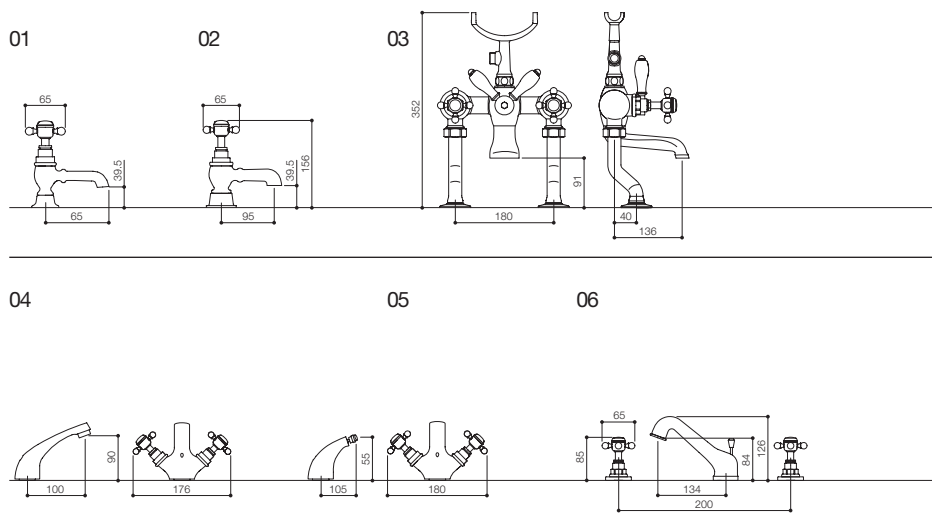

WESTMINSTER RANGE

- 01 WE001 BASIN TAPS
- 02 WE005 BATH TAPS
- 03 WE017 MONO BASIN
- 04 WE021 MONO BIDET
- 05 WE013 BSM

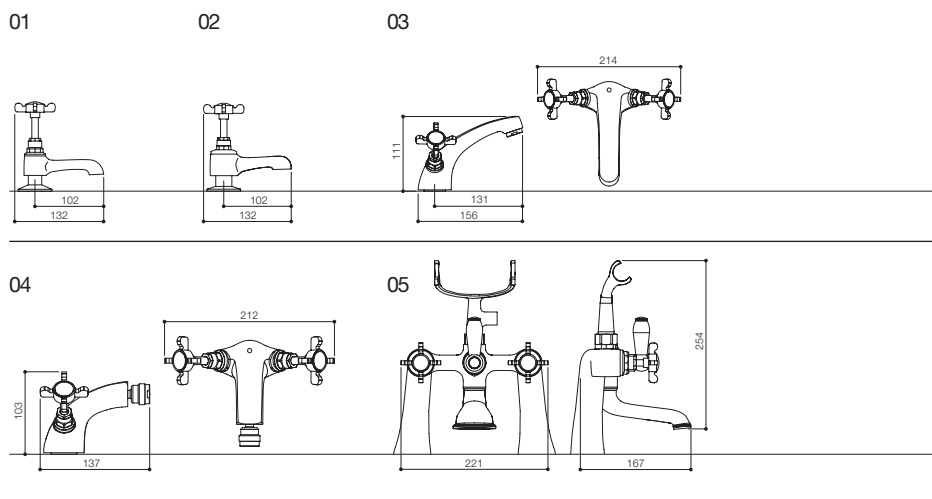

# TAPS & SHOWERS

## TECHNICAL INFORMATION

### JUPITER RANGE

- 01 JP001 BASIN TAPS
- 02 JP003 BATH TAPS
- 03 JP009 MONO BASIN
- 04 JP011 MONO BIDET
- 05 JP005 BATH FILLER
- 06 JP007 BSM
- 07 JP013 3 HOLE BASIN SET

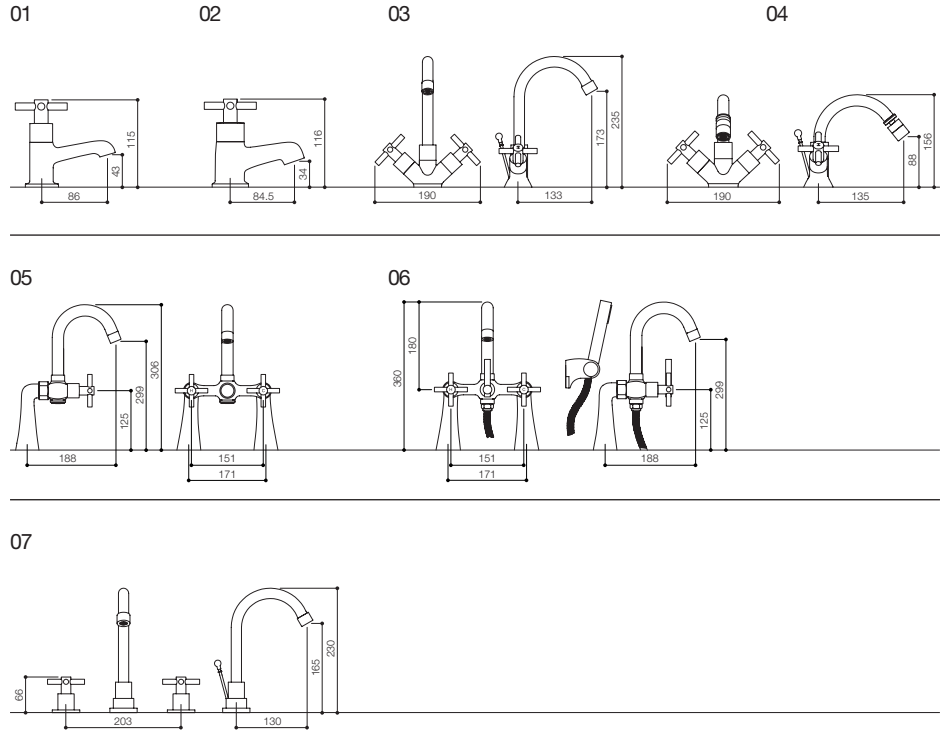

### RITZ RANGE

- 01 RZ001 BASIN TAPS
- 02 RZ005 BATH TAPS
- 03 RZ017 MONO BASIN
- 04 RZ021 MONO BIDET
- 05 RZ013 BSM

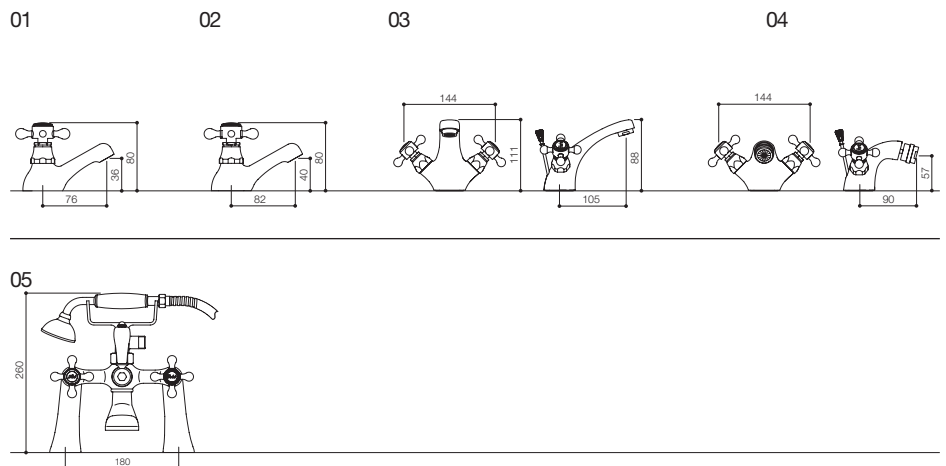



## ICE FALL LEVER FREESTANDING MONO

- 01 IFL019 FREESTANDING MONO (S)
- 02 IFL029 FREESTANDING MONO (M)
- 03 IFL039 FREESTANDING MONO (L)

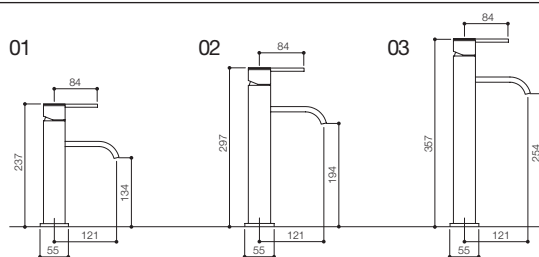

## ICE QUAD LEVER FREESTANDING MONO

- 04 ISL019 FREESTANDING MONO (S)
- 05 ISL029 FREESTANDING MONO (M)
- 06 ISL039 FREESTANDING MONO (L)

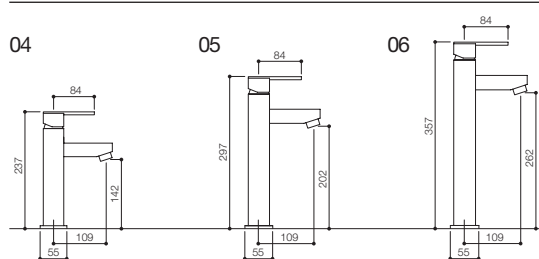

## WAVE FREESTANDING MONO

- 07 RDL019 FREESTANDING MONO (S)
- 08 RDL029 FREESTANDING MONO (M)
- 09 RDL039 FREESTANDING MONO (L)

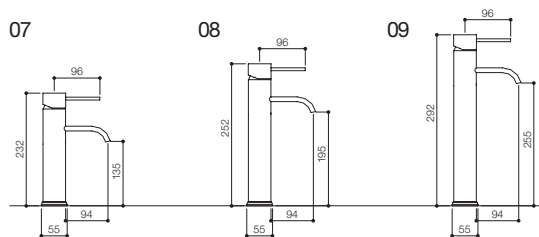

## SERIES K FREESTANDING MONO

- 10 SK001 FREESTANDING MONO (S)
- 11 SK003 FREESTANDING MONO (M)
- 12 SK005 FREESTANDING MONO (L)

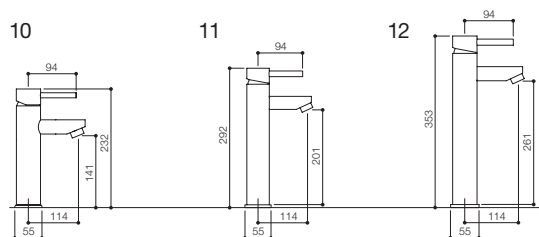

## SERIES N FREESTANDING MONO

- 13 SN001 FREESTANDING MONO (S)
- 14 SN003 FREESTANDING MONO (M)
- 15 SN005 FREESTANDING MONO (L)

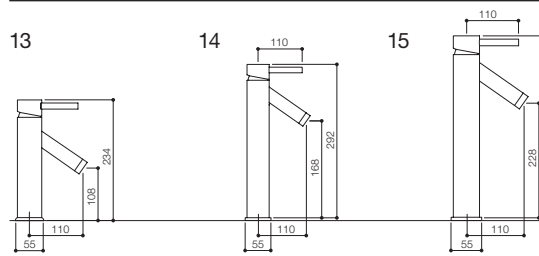

## TECHNICAL INFORMATION

### ORION RANGE

- 01 OR001 BASIN TAPS
- 02 OR003 BATH TAPS
- 03 OR009 MONO BASIN
- 04 OR011 MONO BIDET
- 05 OR005 BATH FILLER
- 06 OR007 BSM
- 07 OR013 SINGLE LEVER MONO BASIN
- 08 OR015 SINGLE LEVER MONO BIDET

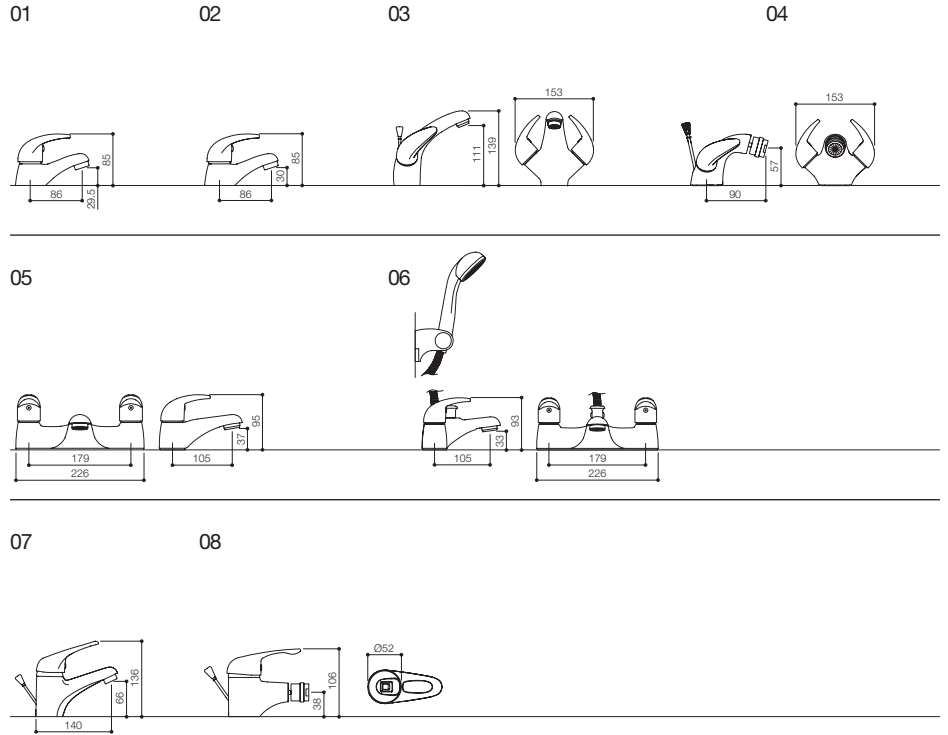

### TITAN RANGE

- 01 TT001 BASIN TAPS
- 02 TT003 BATH TAPS
- 03 TT009 MONO BASIN
- 04 TT011 MONO BIDET
- 05 TT013 SINGLE LEVER MONO BASIN
- 06 TT005 BATH FILLER
- 07 TT015 SINGLE LEVER MONO BIDET
- 08 TT007 BATH SHOWER MIXER

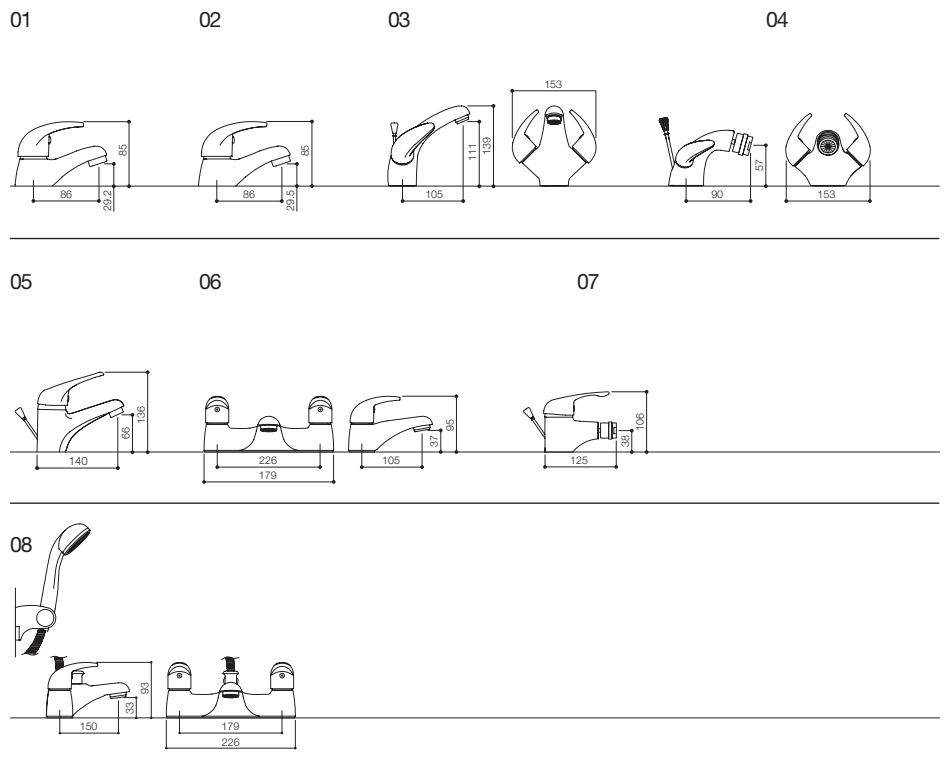

ALPHA RANGE

- 01 AL001 BASIN TAPS
- 02 AL005 BATH TAPS
- 03 AL009 BATH FILLER
- 04 AL013 BATH SHOWER MIXER
- 05 AL017 MONO BASIN
- 06 AL021 MONO BIDET
- 07 KIT127 SINK TAPS
- 08 KIT121 DECK SINK MIXER
- 09 KIT133 MONO SINK MIXER

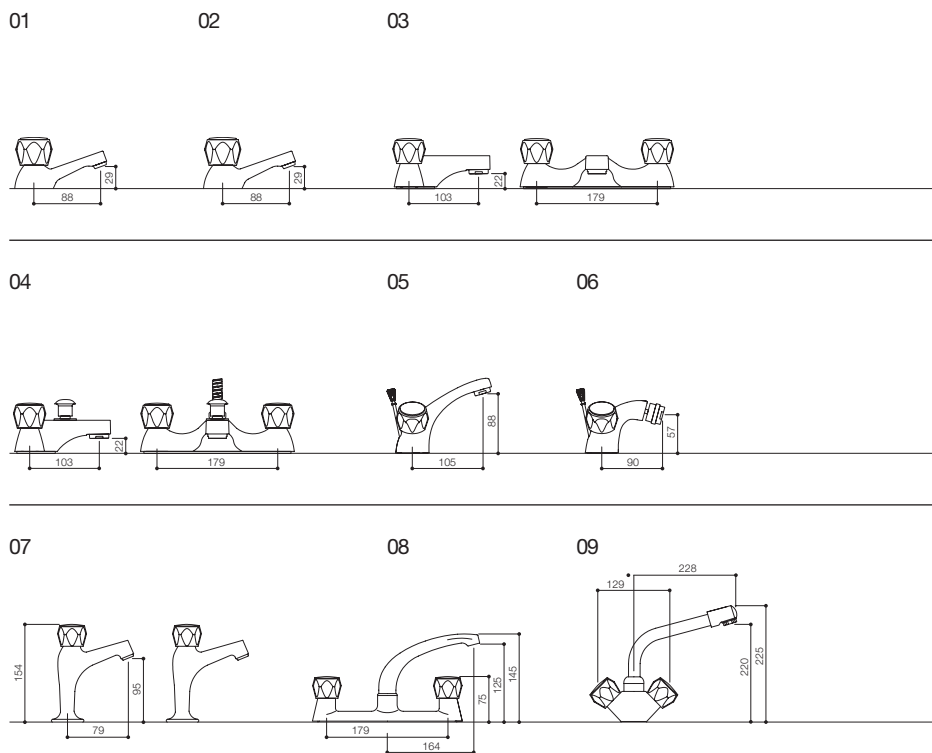

ALPHA RANGE

- 01 AL037 BASIN TAPS
- 02 AL039 BATH TAPS
- 03 AL040 BATH FILLER
- 04 AL041 BATH SHOWER MIXER
- 05 AL043 MONO BASIN
- 06 AL045 MONO BIDET
- 07 KIT131 SINK TAPS
- 08 KIT123 DECK SINK MIXER
- 09 KIT141 MONO SINK MIXER

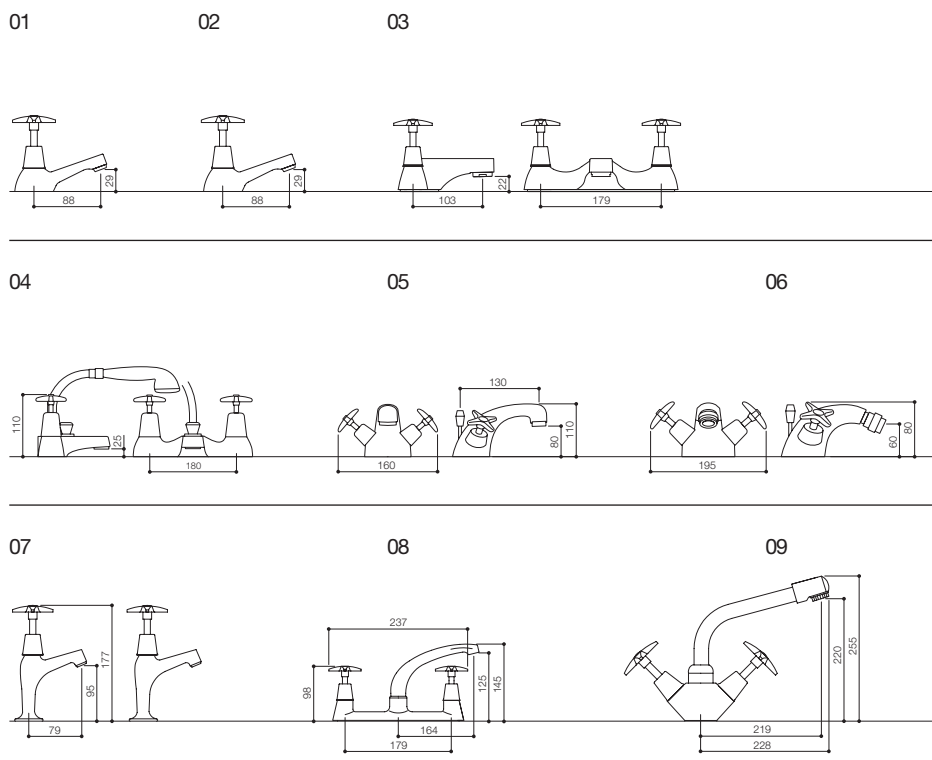

## TECHNICAL INFORMATION

### ALPHA RANGE

- 01 AL047 BASIN TAPS
- 02 AL051 BATH TAPS
- 03 AL055 BATH FILLER
- 04 AL059 BSM
- 05 AL063 MONO BASIN
- 06 AL067 MONO BIDET
- 07 KIT129 SINK TAPS
- 08 KIT125 DECK SINK MIXER
- 09 KIT143 MONO SINK MIXER

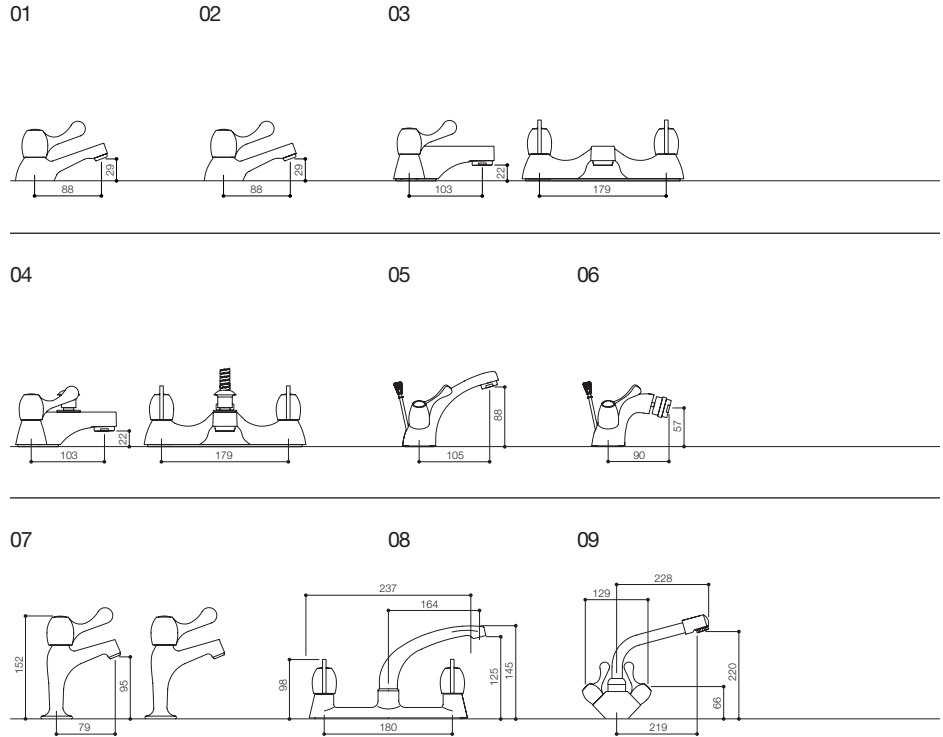

### ALPHA RANGE

- 01 AL027 SELF CLOSING TAPS (L)



AMBER RANGE

- 01 AMB001 BASIN TAPS
- 02 AMB005 BATH TAPS
- 03 AMB009 BATH FILLER
- 04 AMB013 BSM
- 05 AMB017 MONO BASIN
- 06 AMB021 MONO BIDET

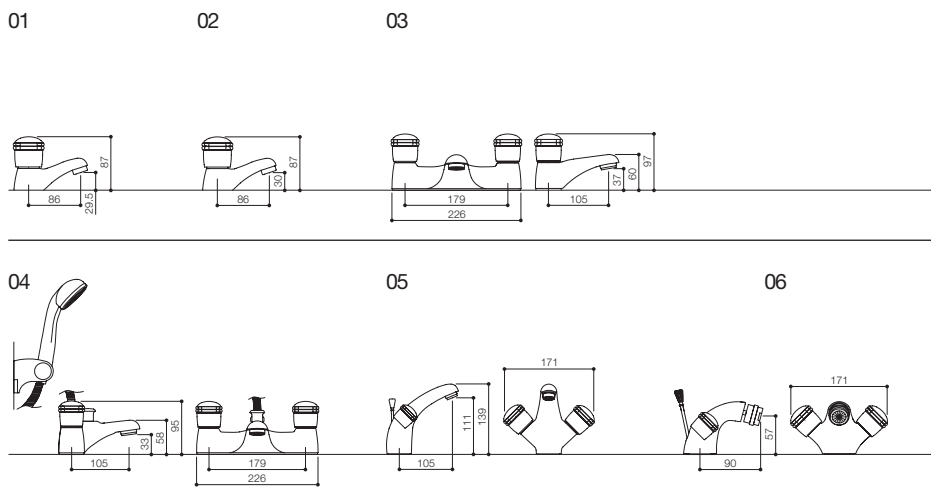

COSMOS RANGE

- 01 COS005 MONO BASIN
- 02 COS007 MONO BIDET
- 03 COS001 BATH FILLER
- 04 COS003 BSM

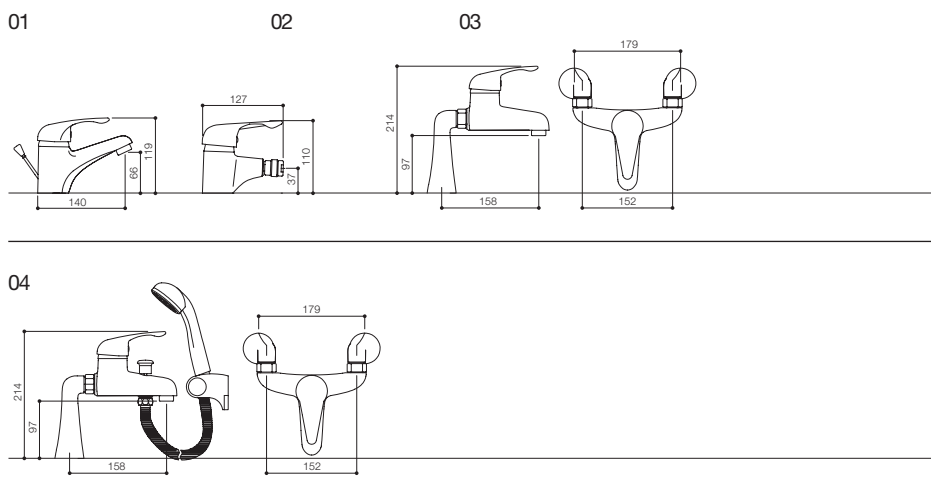

## TECHNICAL INFORMATION

### KITCHEN MONO SINK MIXERS

- 01 KIT009 MARSEILLE DUAL LEVER
- 02 KIT011 ASTOR DUAL LEVER
- 03 KIT015 ASCOT MONO
- 04 KIT017 SYNCRO MONO
- 05 KIT019 ASTRO MONO
- 06 KIT021 ROMA KITCHEN MONO
- 07 KIT023 FLOW KITCHEN TAP
- 08 SER009 SERIES SIDE LEVER MONO
- 09 KIT001 BRISTOL MONO
- 10 KIT005 NOSTALGIA MONO
- 11 KIT007 TITAN MONO PULL-OUT H/SET
- 12 KIT013 APOLLO MONO
- 13 KIT041 COMO LEVER SINK MIXER
- 14 KIT091 MODENA LEVER SINK MIXER
- 15 KIT127 SINK TAPS
- 16 KIT121 DECK SINK MIXER
- 17 KIT133 MONO SINK MIXER
- 18 KIT131 SINK TAPS
- 19 KIT123 DECK SINK MIXER
- 20 KIT141 MONO SINK MIXER
- 21 KIT129 SINK TAPS
- 22 KIT125 DECK SINK MIXER
- 23 KIT143 MONO SINK MIXER

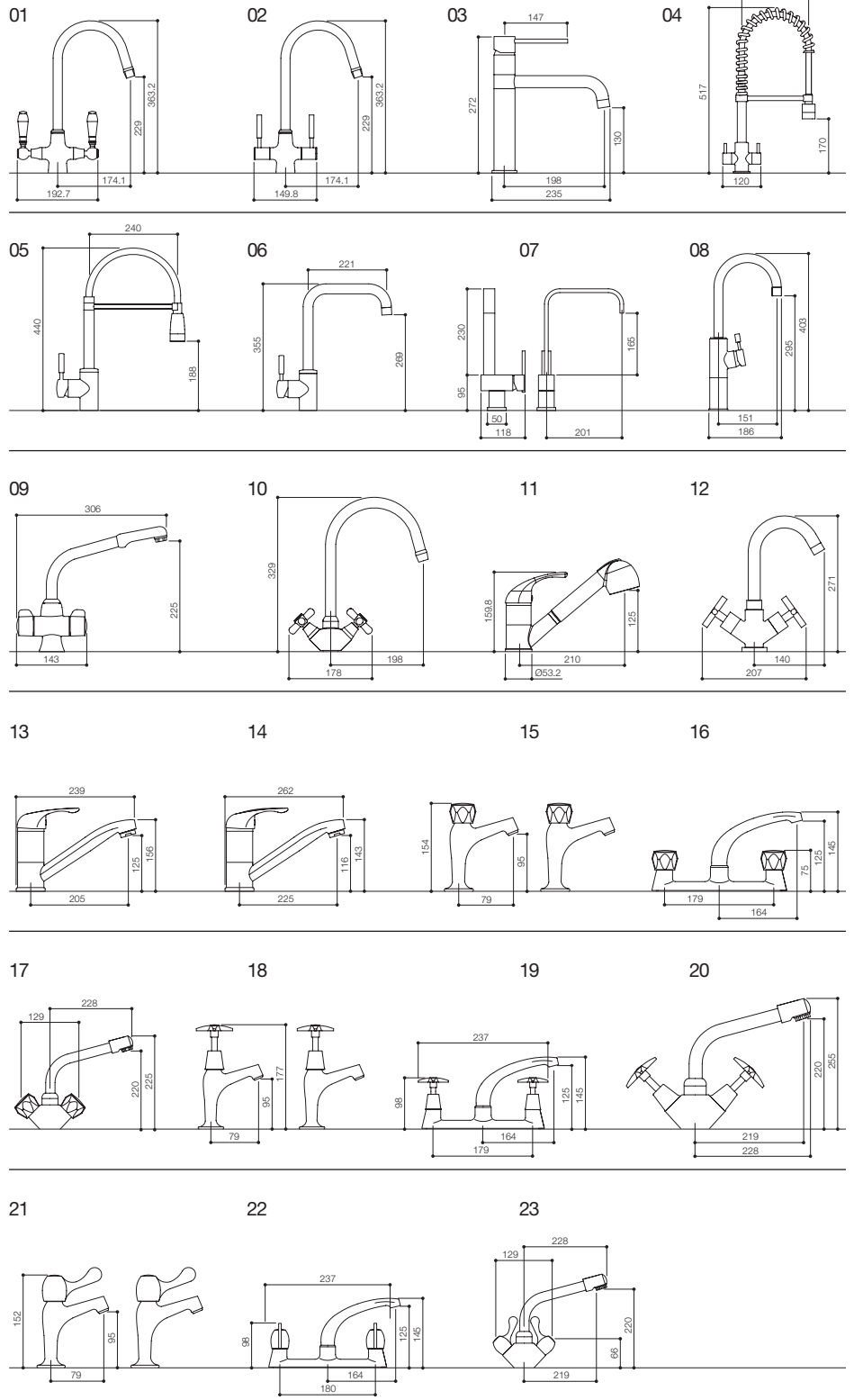



## SWIVEL SPOUT PRODUCT LIST

IFX009	ICE FALL CROSS BASIN MONO	SDX049	SERIES D 3 HOLE BASIN SET	LOL021	LOLI 4 HOLE BATH SET	KIT015	ASCOT MONO
ISX009	ICE QUAD CROSS BASIN MONO	SFL047	SERIES F 4 HOLE BATH SET	TTL009	TAIT LEVER MONO BASIN	KIT041	COMO LEVER SINK MIXER
RDL013	WAVE 3 HOLE BASIN SET	SFL049	SERIES F 3 HOLE BASIN SET	TTX009	TAIT CROSS HEAD MONO BASIN	KIT091	MODENA LEVER SINK MIXER
RDL049	WAVE 4 HOLE BATH SET	SGL047	SERIES G 4 HOLE BATH SET	FLW005	FLOW BATH FILLER	KIT121	ALPHA METAL HEAD DECK SINK MIXER
RDX009	SURF BASIN MONO	SGL049	SERIES G 3 HOLE BASIN SET	FLW007	FLOW BATH SHOWER MIXER	KIT123	ALPHA CROSS HEAD DECK SINK MIXER
RDX013	SURF 3 HOLE BASIN SET	SER009	SIDE LEVER MONO BASIN	FLW009	FLOW MONO BASIN	KIT125	ALPHA LEVER DECK SINK MIXER
RDX049	4 HOLE BATH SET	JP009	JUPITER BASIN MONO	FLW045	FLOW 3 HOLE BATH FILLER	KIT133	ALPHA METAL HEAD MONO SINK MIXER
SCX009	SERIES C BASIN MONO	STC009	STIC BASIN MONO	FLW047	FLOW 4 HOLE BATH SET	KIT141	ALPHA CROSS HEAD MONO SINK MIXER
SCX011	SERIES C BIDET MONO	STC011	STIC BIDET MONO	KIT001	BRISTOL MONO	KIT143	ALPHA LEVER MONO SINK MIXER
SCX047	SERIES C 4 HOLE BATH SET	STC015	STIC 3 HOLE BATH FILLER	KIT005	NOSTALGIA MONO		
SCX049	SERIES C 3 HOLE BASIN SET	STC021	STIC 4 HOLE BATH SET	KIT007	TITAN MONO PULLOUT H/SET		
SDX009	SERIES D BASIN MONO	LOL009	LOLI BASIN MONO	KIT009	MARSEILLE DUAL LEVER		
SDX011	SERIES D BIDET MONO	LOL011	LOLI BIDET MONO	KIT011	ASTOR DUAL LEVER		
SDX047	SERIES D 4 HOLE BATH SET	LOL015	LOLI 3 HOLE BATH FILLER	KIT013	APOLLO MONO		

## PRODUCT PRESSURE TABLE

	BASIN TAPS	BATH TAPS	BATH FILLER	BATH SHOWER MIXER	MONO BASIN	MONO BIDET	3 HOLE BASIN SET	3 HOLE BATH FILLER	4 HOLE BATH SET	5 HOLE BATH SET	1 HOLE BATH FILLER	1 HOLE BATH SHOWER MIXER	CLOAKROOM	FREESTANDING MONO	WALL MOUNTED BATH FILLER	WALL MOUNTED BASIN
ALPHA	0.2 - 6	0.2 - 6	0.2 - 6	0.2 - 6	0.2 - 6	0.2 - 6	•	•	•	•	•	•	•	•	•	•
AMBER	0.2 - 6	0.2 - 6	0.2 - 6	0.2 - 6	0.2 - 6	0.2 - 6	•	•	•	•	•	•	•	•	•	•
BLOX	•	•	0.5 - 6	0.5 - 6	0.5 - 6	•	0.5 - 6	1.0 - 6	1.0 - 6	•	•	•	•	•	•	•
COMET	•	•	0.2 - 6	0.2 - 6	0.2 - 6	•	•	•	•	•	•	•	•	•	•	•
COSMOS	•	•	0.2 - 6	0.2 - 6	0.2 - 6	0.2 - 6	•	•	•	•	•	•	•	•	•	•
FLOW	•	•	0.5 - 6	0.5 - 6	0.5 - 6	•	0.5 - 6	1.0 - 6	1.0 - 6	•	•	•	•	•	•	•
GEM	•	•	0.2 - 6	0.2 - 6	0.2 - 6	0.2 - 6	•	•	•	•	0.2 - 6	0.2 - 6	•	•	•	•
ICE FALL	0.2 - 6	0.2 - 6	0.5 - 6	0.5 - 6	0.2 - 6	•	•	•	•	•	•	•	0.2 - 6	0.2 - 6	•	•
ICE QUAD	0.2 - 6	0.2 - 6	0.5 - 6	0.5 - 6	0.2 - 6	0.2 - 6	•	•	•	•	•	•	0.2 - 6	0.2 - 6	•	•
JET	•	•	0.2 - 6	0.2 - 6	0.2 - 6	0.2 - 6	•	•	•	•	0.2 - 6	0.2 - 6	•	•	•	•
JUPITER	0.2 - 6	0.2 - 6	0.2 - 6	0.2 - 6	0.2 - 6	0.2 - 6	0.2 - 6	•	•	•	•	•	•	•	•	•
KITCHEN	ALL KITCHEN TAPS 0.5 OR ABOVE															
LIU	•	•	0.2 - 6	0.2 - 6	0.2 - 6	•	•	•	•	•	•	•	•	•	•	•
LOLI	0.2 - 6	0.2 - 6	0.5 - 6	0.5 - 6	0.2 - 6	0.2 - 6	0.2 - 6	1.0 - 6	1.0 - 6	•	•	•	0.2 - 6	•	1.0 - 6	0.2 - 6
ONYX	•	•	0.2 - 6	0.2 - 6	0.2 - 6	0.2 - 6	•	•	•	•	0.2 - 6	0.2 - 6	•	•	•	•
ORION	0.2 - 6	0.2 - 6	0.2 - 6	0.2 - 6	0.2 - 6	0.2 - 6	•	•	•	•	•	•	•	•	•	•
QL	0.2 - 6	0.2 - 6	0.2 - 6	0.2 - 6	0.2 - 6	•	•	•	•	•	•	•	•	•	•	•
RENOIR	0.2 - 6	0.2 - 6	•	0.2 - 6	0.2 - 6	0.2 - 6	0.2 - 6	•	•	•	•	•	•	•	•	•
RITZ	0.2 - 6	0.2 - 6	•	0.2 - 6	0.2 - 6	•	0.2 - 6	•	•	•	•	•	•	•	•	•
SERIES C	0.2 - 6	0.2 - 6	0.2 - 6	0.2 - 6	0.2 - 6	0.2 - 6	0.2 - 6	•	1.0 - 6	•	•	•	•	•	•	•
SERIES D	0.2 - 6	0.2 - 6	0.2 - 6	0.2 - 6	0.2 - 6	0.2 - 6	0.2 - 6	•	1.0 - 6	•	•	•	•	•	•	•
SERIES F	0.2 - 6	0.2 - 6	0.2 - 6	0.2 - 6	0.2 - 6	0.2 - 6	0.2 - 6	•	1.0 - 6	•	0.2 - 6	0.2 - 6	0.2 - 6	•	•	•
SERIES G	0.2 - 6	0.2 - 6	0.2 - 6	0.2 - 6	0.2 - 6	0.2 - 6	0.2 - 6	•	1.0 - 6	•	0.2 - 6	0.2 - 6	0.2 - 6	•	•	•
SERIES K	•	•	•	•	•	•	•	•	•	•	•	•	•	0.2 - 6	•	•
SERIES N	•	•	•	•	•	•	•	•	•	•	•	•	•	0.2 - 6	•	•
SERIES P	0.2 - 6	0.2 - 6	0.2 - 6	0.2 - 6	0.2 - 6	0.2 - 6	0.2 - 6	•	1.0 - 6	•	0.2 - 6	0.2 - 6	•	•	•	•
STIC	0.2 - 6	0.2 - 6	0.5 - 6	0.5 - 6	0.2 - 6	0.2 - 6	0.2 - 6	1.0 - 6	1.0 - 6	•	•	•	0.2 - 6	•	1.0 - 6	0.2 - 6
SURF	0.2 - 6	0.2 - 6	0.5 - 6	0.5 - 6	0.2 - 6	•	0.2 - 6	•	1.0 - 6	•	•	•	•	•	•	•
TAIT LEVER	0.2 - 6	0.2 - 6	0.2 - 6	0.2 - 6	0.2 - 6	•	0.2 - 6	1.0 - 6	•	1.0 - 6	•	•	0.2 - 6	•	•	•
TAIT CROSS	0.2 - 6	0.2 - 6	0.2 - 6	0.2 - 6	0.2 - 6	•	0.2 - 6	1.0 - 6	•	1.0 - 6	•	•	•	•	•	•
WAVE	0.2 - 6	0.2 - 6	0.5 - 6	0.5 - 6	0.2 - 6	•	0.2 - 6	•	1.0 - 6	•	•	•	0.2 - 6	0.2 - 6	•	•
WESTMINSTER	0.2 - 6	0.2 - 6	•	0.2 - 6	0.2 - 6	0.2 - 6	•	•	•	•	•	•	•	•	•	•
ZOOM	0.2 - 6	0.2 - 6	0.5 - 6	0.2 - 6	0.2 - 6	•	•	•	•	•	0.2 - 6	0.2 - 6	0.2 - 6	•	•	•

## **Terms & Conditions**

In these terms and conditions 'we' or 'our' means Mayfair Brassware Ltd and 'you' or 'your' means the individual, firm, company or other party with whom we contract.

### **1 Orders**

- 1.1** All prices quoted exclude VAT (unless otherwise stated). VAT will be charged at the time of delivery. Rates of tax and duties on the goods will be those applying at the time of delivery.
- 1.2** Our quotations lapse after 30 days (unless otherwise stated).
- 1.3** Unless otherwise stated, the price quoted is an illustrative estimate only and the price charged will be our price current at the time of delivery.
- 1.4** At any time before the date of despatch we may adjust the contract price to reflect any increase in the costs of manufacturing or our costs of supplying the goods.
- 1.5** Unless we agree otherwise in writing, these terms and conditions apply to our quotation, your order and the contract between us. Once accepted by us, neither your order nor the contract can be varied in any way without our written consent.
- 1.6** Verbal orders are not accepted. All orders must be made in writing (sent via post, fax or email).
- 1.7** All orders over the value of £100 (excluding VAT) will be delivered carriage paid within the UK and Eire. In all other cases, carriage will be charged extra.

### **2 Delivery**

- 2.1** All delivery times quoted are estimates only. Delivery will be made to the address quoted on your order or other communication.
- 2.2** We will use all reasonable efforts to dispatch or deliver the goods within the period quoted, but time for delivery will not be of the essence and we will not be liable for any loss, expense or claim whatsoever caused by late delivery.
- 2.3** We may deliver the goods in instalments. Each instalment is treated as a separate contract.

### **3 Delivery & Safety**

- 3.1** We may decline to deliver if:
  - 3.1.1** we believe that it would be unsafe, unlawful or unreasonably difficult to do so; or
  - 3.1.2** the premises (or the access to them) are unsuitable for our vehicle.

### **4 Risk**

- 4.1** The goods are at your risk from the time of delivery.
- 4.2** Delivery takes place either:
  - 4.2.1** at our premises (if you are collecting them or arranging carriage); or
  - 4.2.2** at your premises (if we are arranging carriage).
- 4.3** You must inspect the goods on delivery. We will not be liable for any shortage unless we are notified in writing within 3 working days of delivery. If any goods are damaged (or not delivered), you must write to tell us within three working days of delivery (or the expected delivery time). You must give us (and any carrier) a fair chance to inspect the damaged goods.

### **5 Payment Terms**

- 5.1** You are to pay us in cash or otherwise in cleared funds on delivery, unless you have an approved credit account.
- 5.2** If you have an approved credit account, payment is due no later than the end of the month following the month of the invoice unless otherwise agreed in writing.
- 5.3** If you fail to pay us in full on the due date:
  - 5.3.1** we may suspend or cancel future deliveries;
  - 5.3.2** we may cancel any discount offered to you;
  - 5.3.3** you must pay us interest at the rate set under s.6 of the Late Payment of Commercial Debts (Interest) Act 1998
    - a.** calculated (on a daily basis) from the date of our invoice until payment;
    - b.** compounded on the first day of each month; and
    - c.** before and after any judgment (unless a court orders otherwise);
  - 5.3.4** we may claim fixed sum compensation from you under s.5A of that Act to cover our credit control overhead costs; and
  - 5.3.5** we may recover (under clause 5.7) the cost of taking legal action to make you pay.
- 5.4** If you have an approved credit account, we may withdraw it or reduce your credit limit or bring forward your due date for payment. We may do any of those at any time without notice.
- 5.5** You do not have the right to set off any money you may claim from us against anything you may owe us.
- 5.6** You are to indemnify us in full and hold us harmless from all expenses and liabilities we may incur (directly or indirectly including financing costs and including legal costs on a full indemnity basis) following any breach by you of any of your obligations under these terms

### **6 Title**

- 6.1** Until you pay all debts you may owe us:
  - 6.1.1** all goods supplied by us remain our property;
  - 6.1.2** you must store them so that they are clearly identifiable as our property;
  - 6.1.3** you must insure them (against the risks for which a prudent owner would insure them) and hold the policy on trust for us;
  - 6.1.4** you may use those goods and sell them in the ordinary course of your business, but not if:
    - a.** we revoke that right (by informing you in writing); or
    - b.** you become insolvent.
- 6.2** You must inform us (in writing) immediately if you become insolvent.
- 6.3** If your right to use and sell the goods ends you must allow us to remove the goods.
- 6.4** We have your permission to enter any premises where the goods may be stored:
  - 6.4.1** at any time, to inspect them; and
  - 6.4.2** after your right to use and sell them has ended, to remove them, using reasonable force if necessary.
- 6.5** Despite our retention of title to the goods, we have the right to take legal proceedings to recover the price of goods supplied should you not pay us by the due date.
- 6.6** You are not our agent. You have no authority to make any contract on our behalf or in our name.

### **7 Warranties**

- 7.1** We warrant that the goods:
  - 7.1.1** comply with their description on our acknowledgement of order form; and
  - 7.1.2** are free from material defect at the time of delivery (as long as you comply with clause 7.3).
- 7.1.3** are guaranteed against material defects in manufacturing or workmanship for a period of ten years from the date of delivery. This does not apply to goods that have not been properly installed, used, and maintained under normal domestic conditions in accordance with our instructions
- 7.2** We give no other warranty (and exclude any warranty, term or condition that would otherwise be implied) as to the quality of the goods or their fitness for any purpose.
- 7.3** If you believe that we have delivered goods which are defective in materials or workmanship, you must:
  - 7.3.1** inform us (in writing), with full details, as soon as possible; and
  - 7.3.2** allow us to investigate (we may need access to your premises and product samples).
- 7.4** If the goods are found to be defective in material or workmanship (following our investigations), and you have complied with those conditions (in clauses 7.1.3 and 7.3) in full, we will, at our option, replace the goods or refund the purchase price.
- 7.5** We are not liable for any other loss or damage (including indirect or consequential loss, financial loss, loss of profits or loss of use) arising from the contract or the supply of goods or their use, even if we are negligent.
- 7.6** For all other liabilities not referred to elsewhere in these terms our liability is limited in damages to the price of the goods.
- 7.7** Nothing in these terms restricts or limits our liability for death or personal injury resulting from negligence.

### **8 Specification**

- 8.1** If we supply the goods in accordance with your specifications or instructions:
  - 8.1.1** you must ensure that the specifications or instructions are accurate and
  - 8.1.2** you must ensure that goods supplied in accordance with those specifications or instructions will be fit for the purpose for which you intend to use them.
- 8.2** We reserve the right to make any changes in the specifications of our goods which are necessary to ensure they conform to any applicable safety or other statutory requirements.
- 8.3** We also reserve the right to make without notice any minor modifications in our specifications we think necessary or desirable.

### **9 Return Of Goods**

- 9.1** We will accept the return of goods from you only:
  - 9.1.1** by prior arrangement (confirmed in writing) and when you follow our standard returns procedure.
  - 9.1.2** on payment of an agreed handling charge (unless the goods were defective when delivered); and
  - 9.1.3** where the goods are as fit for sale on their return as they were on delivery.

### **10 Export Terms**

- 10.1** Where the goods are supplied by us to you by way of export from the United Kingdom Clause 10 of these terms applies (except to the extent that it is inconsistent with any written agreement between us).
- 10.2** The 'Incoterms' of the International Chamber of Commerce which are in force at the time when the contract is made apply to exports, but these terms prevail to the extent that there is any inconsistency.
- 10.3** Unless otherwise agreed, the goods are

supplied ex works - Sherburn in Elmet, near Leeds.

- 10.4** Where the goods are to be sent by us to you by a route including sea transport we are under no obligation to give a notice under section 32(3) of the Sale of Goods Act 1979.
- 10.5** You are responsible for arranging testing and inspection of the goods at our premises before shipment (unless otherwise agreed). We are not liable for any defect in the goods which would be apparent on inspection unless a claim is made before shipment. We are not liable for any damage during transit.
- 10.6** We are not liable for death or personal injury arising from the use of the goods delivered in the territory of another State (within the meaning of s.26 (3) (b) Unfair Contract Terms Act 1977).

### **11 Cancellation**

- 11.1** If the order is cancelled (for any reason) you are then to pay us for all stock (finished or unfinished) that we may then hold (or to which we are committed) for the order.
- 11.2** We may suspend or cancel the order, by written notice if:
  - 11.2.1** you fail to pay us any money when due (under the order or otherwise);
  - 11.2.2** you become insolvent;
  - 11.2.3** you fail to honour your obligations under these terms.
- 11.3** You may not cancel the order unless we agree in writing (clause 11.1 then applies) and you then can have no further claim against us

### **12 Waiver & Variations**

- 12.1** Any waiver or variation of these terms is binding in honour only unless:
  - 12.1.1** made (or recorded) in writing;
  - 12.1.2** signed on behalf of each party; and
  - 12.1.3** expressly stating an intention to vary these terms.
- 12.2** All orders that you place with us will be on these terms (or any that we may issue to replace them). By placing an order with us, you are expressly waiving any printed terms you may have to the extent that they are inconsistent with our terms.

### **13 Force Majeure**

- 13.1** If we are unable to perform our obligations to you (or able to perform them only at unreasonable cost) because of circumstances beyond our control, we may cancel or suspend any of our obligations to you, without liability.
- 13.2** Examples of those circumstances include act of God, accident, explosion, war, terrorism, fire, flood, transport delays, strikes and other industrial disputes and difficulty in obtaining supplies.

### **14 General**

- 14.1** English law is applicable to any contract made under these terms. The English and Welsh courts will have exclusive jurisdiction.
- 14.2** If you are more than one person, each of you has joint and several obligations under these terms.
- 14.3** If any of these terms are unenforceable as drafted:
  - 14.3.1** it will not affect the enforceability of any other of these terms; and
  - 14.3.2** if it would be enforceable if amended, it will be treated as so amended.
- 14.4** We may treat you as insolvent if:
  - 14.4.1** you are unable to pay your debts as they fall due; or
  - 14.4.2** you (or any item of your property) become the subject of:
    - a.** any formal insolvency procedure (examples of which include receivership, liquidation, administration, voluntary arrangements (including a moratorium) or bankruptcy);
    - b.** any application or proposal for any formal insolvency procedure; or
    - c.** any application, procedure or proposal overseas with similar effect or purpose.
- 14.5** All brochures, catalogues and other promotional materials are to be treated as illustrative only. Their contents form no part of any contract between us and you should not rely on them in entering into any contract with us.
- 14.6** Any notice by either of us which is to be served under these terms may be served by leaving it at or by delivering it to (by first class post or by fax) the other's registered office or principal place of business. All such notices must be signed.
- 14.7** No contract will create any right enforceable (by virtue of the Contracts (Rights of Third Parties) Act 1999) by any person not identified as the buyer or seller.
- 14.8** The only statements upon which you may rely in making the contract with us, are those made in writing by someone who is our authorised representative and either:
  - 14.8.1** contained in our estimate (or any covering letter) and not withdrawn before the contract is made; or
  - 14.8.2** which expressly state that you may rely on them when entering into the contract.
- 14.9** Nothing in these terms affects or limits our liability for fraudulent misrepresentation

# CUSTOMER CHARTER

At Mayfair Taps and Showers, design, cost, service and quality are the cornerstones of our business. Quality control and customer service are very important to us and we are constantly working to improve our people and processes.

As one of the UK's largest manufacturers and distributors of taps and showers, we have recently become a member of the Bathroom Manufacturers Association demonstrating our commitment to the industry.

## NEXT DAY DELIVERY

We endeavour to provide next day delivery on the majority of our product orders provided they are placed before 2pm and are available from stock. Orders can be placed by email, EDI or fax.

## RETAIL PRICES

All retail prices stated are inclusive of VAT.

## CUSTOMER RELATIONS

We are expanding our workforce of Mayfair representatives to ensure that you receive a high quality service through regular and frequent visits from us.

If you require technical information on any of our products you can call 01977 686 560 for assistance.

## WATER REGULATIONS ADVISORY SCHEME (WRAS)

All Mayfair products are either WRAS approved or pending WRAS approval. This means that they will undergo rigorous testing by the WRC-NSF to ensure complete compliance with all the UK water regulations.

## RETURNED GOODS

Faulty or damaged goods can be returned to Mayfair and a full refund will be provided upon inspection. A Mayfair Returns Note must be provided, clearly stating which goods are being returned and the reasons for doing so.

## GUARANTEE

All Mayfair products are guaranteed against defect in manufacture for 10 years (unless otherwise stated). Showers will carry a 3 year guarantee.

This guarantee does not cover products which have been wrongly installed or misused in any way.

## CLEANING & CARE

Products should be cleaned regularly using a clean damp cloth, abrasive or cream cleaners should not be used under any circumstances.



Member of the BMA



WRAS Approved

TAPS &  
SHOWERS

## CONTACT DETAILS

Mayfair Taps & Showers  
Mayfair House  
Unit 8 Hurricane Close  
Lancaster Business Park  
Sherburn-In-Elmet  
Leeds LS25 6PB

Sales Office  
T 01977 685 770  
F 01977 683 359

Customer Services  
T 01977 686 560  
F 01977 686 561

[sales@mayfairsandshowers.com](mailto:sales@mayfairsandshowers.com)  
[mayfairsandshowers.com](http://mayfairsandshowers.com)

mayfair